

DELUXEPAINT™ II

GETTING STARTED

Your **DeluxePaint II** package consists of two disks: the program disk (described in the manual) and a bonus art disk containing images created with **DeluxePaint II**. Before you use **DeluxePaint** you should make one or more working copies of the program disk. By making a backup copy, you will be protected in case anything happens to your original disk. You might also want to initialize some data disks for saving your artwork. (See your IIGS documentation for instructions on initializing and copying disks.)

To start **DeluxePaint**, insert your working copy of **DeluxePaint** and turn on your computer and monitor. This guarantees that the tools in the system directory are the correct versions for your copy of **DeluxePaint**. To launch the program, simply double-click on the **DeluxePaint** name in the Launcher. If you are using a *two-drive* system, put your working copy of the program in Drive 1 and the original in Drive 2; after the program has loaded you can eject the original and replace it with the **DeluxePaint** art disk or your initialized data disk. If you are using a *single drive*, you will get a message asking you to insert the original disk. In that case, eject the copy and insert the original **DeluxePaint** program disk. When the drive stops spinning, eject the original and put it back into storage.

When you quit **DeluxePaint** (by selecting **Quit** from the **File** menu), you will be taken back to the Launcher, from which you can launch any other application. Anything you have saved to the Clipboard from within **DeluxePaint** will be saved when you switch to the new application, which means you can move images out of **DeluxePaint** and into another application.

MEMORY CONSIDERATIONS

DeluxePaint needs at least 768K of memory to run. Some of **DeluxePaint's** features (such as Fixed Background, Stencils, and Spare Page) consume more memory than others, and you may not be able to use all of them simultaneously with the minimum amount of memory. In particular, with 768K you can fix the background (see your manual for information on this feature), or you can use all the other memory intensive features, but not both at once. If you wish to use all of **DeluxePaint's** features simultaneously, you will need to upgrade your RAM to one megabyte or more.

Irrespective of the amount of memory you have available, some painting operations take longer to complete than others. In particular, when using some of the perspective options (such as High Anti-aliasing, for example) you may find that it takes several minutes to paint a rotated brush. No watch cursor is visible during these operations.

PRINTING

PAGE SETUP: Before printing your work, make sure that the **Page Setup** information is correct. Select **Page Setup** from the **File** menu and then select from the following options:

Paper: Select paper size.

Special Effects: Check the box if you want to leave no gaps between pages.

Orientation: Select from Portrait or Landscape by clicking the appropriate icon.

CHOOSE PRINTER: If you are using a printer other than Apple's ImageWriter, you will need to make the appropriate selection from the **Choose Printer** dialog box. Click the appropriate printer, and the port the printer is connected to (Printer, Modem, or Appletalk). Click OK to use your settings. **Note:** Your **DeluxePaint** disk comes installed with the ImageWriter driver only. If you want to use another printer, you will need to install the correct driver for that printer. Consult your dealer for information.

PRINT: Selecting **Print...** from the **File** menu produces the **Print** dialog box, allowing you to choose from various printing options. These options are summarized as follows:

Quality: For best results, choose **Better Color**.

Page Range: **DeluxePaint** ignores this setting.

Copies: Enter the number of copies you wish to print.

Paper Feed: Select **Automatic** if you are using tractor feed paper or **Hand Feed** if you are using single sheets.

Color: Check the **Color** box if you wish to print in color. Leave it unchecked to print in **Black and White**.

CUT, COPY and PASTE

These functions allow you to move images from the Clipboard to your brush, and vice versa. When you select **Cut**, your current brush image is placed onto the Clipboard, and replaced with the single-pixel brush. **Copy** places a copy of your current brush onto the Clipboard, without affecting the brush. **Paste** places a copy of the the Clipboard onto your brush, replacing the previous image.

If you want to move an image into a program that doesn't use Apple's Preferred File Format, you can do so by using the **EA Screen Saver** utility. To access this utility, first prepare the screen you want to save (for example, you may want to press 0 first to remove the Menu Bar and the Tool Box), and then press the **Esc** key while holding down both the **Control** and the **Open Apple** keys. To save the current screen, select **EA Screen Saver**. The first screen you save is saved as **Screen.0**, the second as **Screen.1**, etc. You can rename these later to more closely describe their contents. **Note:** If you attempt to use **Screen Saver** and the computer beeps, select **Save Picture** from the **File** menu to see if the disk is write-protected or full. Select **Cancel** to return to the painting screen.

THE BONUS ART DISK

This disk contains art created with **DeluxePaint**. Be sure to try color cycling (press the **Tab** key to toggle it on and off) when you look at the paintings in the folder labeled **Cycle.Me**.

KEYBOARD COMMAND SUMMARY

Use the following keyboard equivalents as shortcut methods for accessing DeluxePaint's features.

BRUSH COMMANDS

1	Matte mode
2	Color mode
3	Replace mode
4	Smear mode
5	Shade mode
6	Blend mode
7	Cycle mode
8	Smooth mode
-	Reduce brush size
Shift -	Reduce brush size twice as much as -
=	Increase brush size
Shift =	Increase brush size twice as much as =
Z	Stretch
h	Halve
H	Double
x	Flip horizontal
X	Double horizontal
y	Flip vertical
Y	Double vertical
z	90 degree rotate

(For 1-8, use the number keys on the main part of the keyboard, above the alphabet.)

PERSPECTIVE COMMANDS

X-Axis Commands:

Keypad 7 and 8	Rotate about the x-axis
Shift Keypad 7 and 8	Rotate 90 degrees about the x-axis (default)
Keypad 9	Reset x-axis to zero
Shift Keypad 9	Fix x-axis

Y-Axis Commands:

Keypad 4 and 5	Rotate about the y-axis
Shift Keypad 4 and 5	Rotate 90 degrees about the y-axis (default)
Keypad 6	Reset y-axis to zero
Shift Keypad 6	Fix y-axis

Z-Axis Commands:

Keypad 1 and 2

Shift Keypad 1 and 2

Keypad 3

Shift Keypad 3

Rotate about the z-axis

Rotate 90 degrees about the z-axis (default)

Reset z-axis to zero

Fix z-axis

Other Commands:

Enter

Keypad . (Decimal Point)

Keypad 0

Shift Keypad 0

Keypad - (Minus)

; and '

: and " (Shift ; and ')

< and > (Shift . and Shift ,)

Enter Perspective mode.

Reset perspective center.

Reset all axes to zero.

Reset all axes to zero and perspective center to default state.

Fill the screen with the current brush at the current perspective.

Move the brush along the fixed axis in a direction perpendicular to the brush plane.

Same as ; and ' keys but with a greater increment.

Modify observer distance from screen.

Using Perspective Commands If You Don't Have a Keypad:

Hold down the Closed Apple () key and press the corresponding number key on the main part of the keyboard, above the alphabet. In place of Shift and a keypad number, hold down the Shift and the Closed Apple keys and press the corresponding number key on the main keyboard.

TOOLBOX COMMANDS

b

Brush Selector tool; if clicked again, Corral tool

B

Restore last custom brush

c

Unfilled Circle tool

C

Filled Circle tool

d

Continuous Freehand tool

D

Continuous Freehand tool with 1-pixel brush

e

Unfilled Ellipse tool

E

Filled Ellipse tool

f

Fill tool

F

Fill Type Dialog Box

g

Grid

G

Grid to current brush position

J

Spare page

K

Clear page

m

Toggle Magnify tool

p

Palette Window

q

Curve tool

r

Unfilled Rectangle tool

R

Filled Rectangle tool

s

Dotted Freehand tool

t Text
u Undo
v Straight Line tool
> Zoom in (to enlarge magnified image)
< Zoom out (to shrink magnified image)
, Select Color cursor
[and] Move Color Selector up and down the palette
. One-pixel brush
/ Toggle Symmetry

PALETTE WINDOW COMMANDS

n Display Color Settings Dialog Box
u Undo last color change
1, 2, 3, or 4 Select Range 1, 2, 3, or 4
[and] Move Color Selector up and down
<- and -> Move top end of Range bracket up and down
^ and v Move bottom end of Range bracket up and down

SPECIAL KEYS

9 Toggle Info Bar
0 Toggle Menu Bar and Toolbox/Palette
ESC Toggle cursor
Cursor keys Scroll page; in Text mode, move cursor under the cursor; in Magnify mode, move area under the cursor to center of magnified area
n Constrain with Rectangle, Straight Line, and Polygon tools
Shift Leave traces with Line or Shape tools
CTRL Check memory
CTRL a Toggle color cycle
Tab Show page
S Toggle stencil
. (to left of Spacebar) Repeat last menu option (Again key)
a Spacebar Abort current command

(For 9 and 0, use the number keys on the main part of the keyboard.)

LIMITED WARRANTY

Limited Warranty. Electronic Arts ("EA") provides to the original purchaser of the computer software product, for a period of ninety (90) days from the date of original purchase (the "Warranty Period"), the following limited warranties:

Media: EA warrants that, under normal use, the magnetic media and the packaging provided with it are free from defects in materials and workmanship.

Software: EA warrants that the software, as originally purchased, will perform substantially in conformance with the specifications set forth in the packaging and in the user manual.

Warranty Information. If you are having any problems with the product, we are happy to help. Please address all correspondence to Electronic Arts, 1820 Gateway Drive, San Mateo, California 94404. Or call us at (415) 572-ARTS.

Warranty Claims. To make a warranty claim under this limited warranty, please return the product to the point of purchase, accompanied by proof of purchase, a statement of the defect, and your name and return address. To replace defective media after expiration of the Warranty Period, send the product, in protective packaging, postage prepaid, to Electronic Arts, at the above address, enclosing proof of purchase, a statement of the defect, your name and return address, and a check for \$7.50. EA or its authorized dealer will, at its option, repair or replace the product, and return it to you, postage prepaid, or issue you with a credit equal to the purchase price. THE FOREGOING STATES THE PURCHASER'S SOLE AND EXCLUSIVE REMEDY FOR ANY BREACH OF WARRANTY WITH RESPECT TO THE SOFTWARE PRODUCT.

Warranty Exclusions. EA EXPRESSLY DISCLAIMS ANY IMPLIED WARRANTIES WITH RESPECT TO THE MEDIA AND THE SOFTWARE, INCLUDING WARRANTIES OF MERCHANTABILITY OR FITNESS FOR A PARTICULAR PURPOSE. ANY WARRANTIES IMPLIED BY LAW ARE LIMITED IN DURATION TO THE WARRANTY PERIOD. SOME STATES DO NOT ALLOW LIMITATIONS ON THE DURATION OF AN IMPLIED WARRANTY, SO THE ABOVE LIMITATION MAY NOT APPLY TO YOU. THIS WARRANTY GIVES YOU SPECIFIC LEGAL RIGHTS. YOU MAY ALSO HAVE OTHER RIGHTS WHICH VARY FROM STATE TO STATE.

LIMITATIONS ON DAMAGES

EA SHALL NOT IN ANY CASE BE LIABLE FOR INCIDENTAL, CONSEQUENTIAL OR OTHER INDIRECT DAMAGES ARISING FROM ANY CLAIM UNDER THIS AGREEMENT, EVEN IF EA OR ITS AGENTS HAVE BEEN ADVISED OF THE POSSIBILITY OF SUCH DAMAGES. SOME STATES DO NOT ALLOW THE EXCLUSION OR LIMITATION OF INCIDENTAL OR CONSEQUENTIAL DAMAGES, SO THE ABOVE LIMITATION OR EXCLUSION MAY NOT APPLY TO YOU.

APPLE COMPUTER, INC. MAKES NO WARRANTIES, EITHER EXPRESS OR IMPLIED, REGARDING THE ENCLOSED COMPUTER SOFTWARE PACKAGE, ITS MERCHANTABILITY OR ITS FITNESS FOR ANY PARTICULAR PURPOSE. THE EXCLUSION OF IMPLIED WARRANTIES IS NOT PERMITTED BY SOME STATES. THE ABOVE EXCLUSION MAY NOT APPLY TO YOU. THIS WARRANTY PROVIDES YOU WITH SPECIFIC LEGAL RIGHTS. THERE MAY BE OTHER RIGHTS THAT YOU MAY HAVE WHICH VARY FROM STATE TO STATE.

Unless indicated otherwise, all software and documentation are © 1987 Electronic Arts. All Rights Reserved.

Art Credits

Richard Antiaki: *Pattern Sets I & II, Seascape*; Keith J. Masavage & Frank Ranum (Associated Computer Services): *Architect Brushes, Architect Sample*; Avril Harrison: *Dan Silva, King Tut, Venus, Wolf, Eiffel Tower*; Greg Johnson: *Bees, Paintcan, Blodomes, Castle, Gorilla, Sleeping Alien, Starflight*; Greg Johnson & Avril Harrison: *Lemur*; Louis Johnson: *Lost Ark, Iris, Triceratops*; Paul Reiche III: *Fantasy Background, Fantasy Sets I & II, Xmas Background, Xmas Set*; Dan Silva: *Moondance, Hall of Stars, Waterfall*; Brian Williams: *Apple II GS, Racer*.

DELUXE

Paint II



MANUAL
FOR YOUR APPLE IIGS



ELECTRONIC ARTS®
DELUXE CREATIVITY SERIES

DELUXE

Paint II

MANUAL



DAN SILVA

Dan Silva's interest in computers and computer graphics dates back to the early sixties, when he was working towards his Master's degree in Mechanical Engineering at Stanford University. At that time he was using a computer to synthesize kinematic linkages, such as robot arms and universal joints. Like most computer programmers during that time, Dan was using the computer to avoid computational tedium, with no inkling that it would one day become a tool for self-expression and creativity.

He began to realize the computer's potential for creative self-expression during his four years with Informatics, a contractor to the NASA Ames laboratory. During his spare time there, Dan wrote an interactive language for displaying mathematical equations as graphic images. Like many computer programming pioneers, Dan did his most interesting work after hours, when the computers would otherwise have been sitting idle.

It was in 1978, when he started working for Xerox (doing user interface design for the Xerox Star system), that Dan realized he could make a living having fun with computers. There followed a year at the newly formed computer group at Lucasfilm designing a video editor, and then back to Xerox, where he worked with Bill Bowman creating a next-generation bitmap editor. This effort produced Doodle, a Black and White paint program running on the Xerox Dandelion computer.

By the time Dan joined Electronic Arts in 1983, he had a clear idea of how the ideal paint program should behave. With this in mind, he started work on Prism, a paint program that was to be an in-house tool for software development. Needless to say, as Prism grew, so did its marketplace potential, especially with the advent of new color-graphics-oriented computers. **DeluxePaint** was released in November, 1985 for the Commodore Amiga; and Dan started work on **DeluxePaint II** almost immediately. This version of **DeluxePaint II** has been adapted to take full advantage of the capabilities of Apple's powerful new IIGS computer.

Dan and Patricia live in Mill Valley, California with their 18-year old cat Pansy. Dan takes advantage of long compile times to keep in practice on the piano and guitar, and enjoys hiking, bicycling, and playing Go.



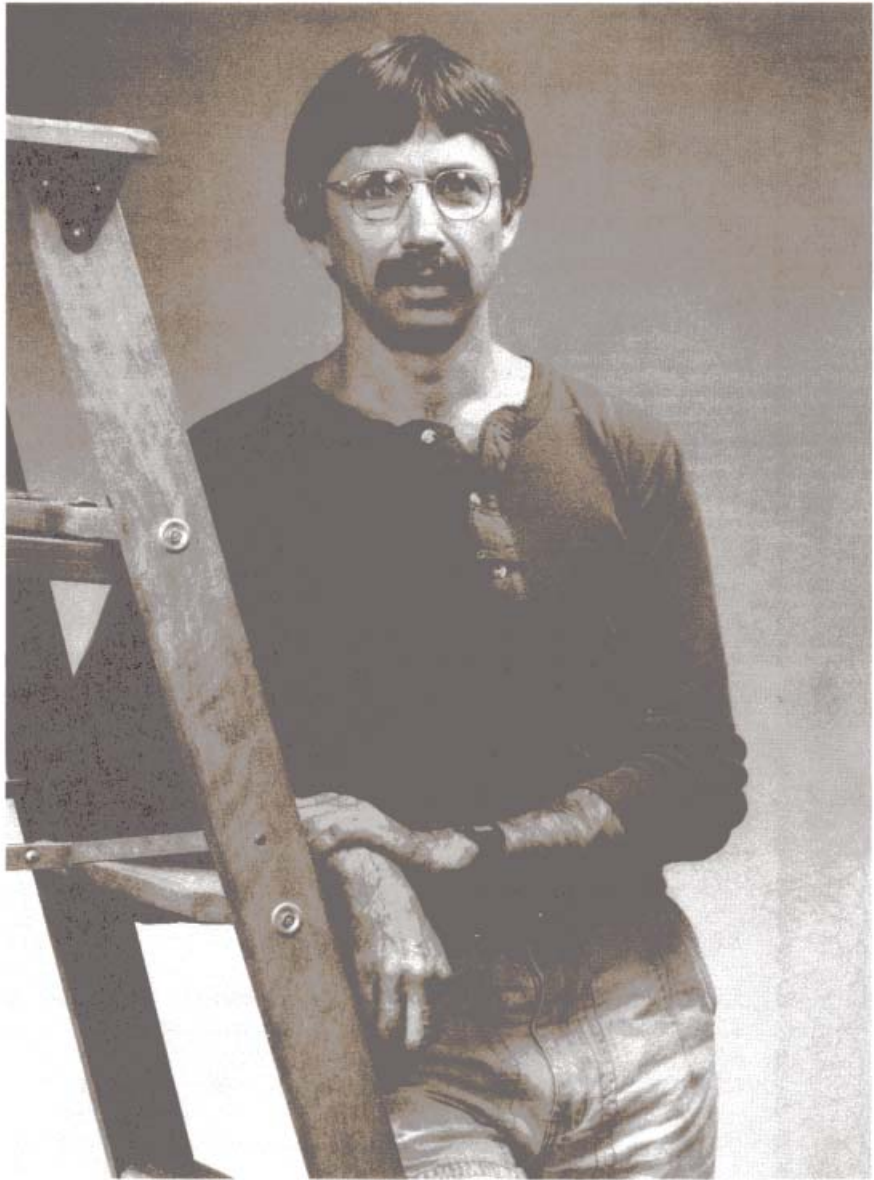

Upgrade Certificate

DeluxePaint II

Apple IIGS

As a registered owner of DeluxePaint II, you are entitled to receive future upgrades of the product for a nominal cost. This Certificate is your proof of ownership, and allows you to take advantage of future upgrades. Be careful not to lose it. Upgrades could include enhancements or refinements for increased power, efficiency and features.

Do not send this Certificate until you are notified.

At the appropriate time, we will notify you about an upgrade to this product, and invite you to send in this Certificate to receive your upgrade. Because we can notify only registered owners, make sure you send in the Registration Card included with your package.

This Certificate is provided for the use of registered DeluxePaint II owners only. No photocopies or facsimiles will be accepted.

Name

Address

City *State* *ZIP*

Home Phone *Business Phone*

Please allow four to six weeks for delivery

No. 49602B

TABLE OF CONTENTS

TABLE OF CONTENTS

	Page
Introduction	1.1
Why Computer Graphics?.....	1.2
About This Manual.....	1.4
Chapter One: A Guided Tour	1.1
1. Getting Started.....	1.1
Software.....	1.1
Hardware.....	1.1
Organizing Your Disks.....	1.1
Power Up.....	1.2
2. Getting Acquainted.....	1.3
The Palette.....	1.3
Painting with the mouse.....	1.5
The Toolbox.....	1.6
The Built-in Brushes.....	1.6
The Tools.....	1.7
Anything Can Be A Brush.....	1.11
3. Getting Going.....	1.12
Saving Your Work.....	1.12
Loading A Picture.....	1.14
Night and Day.....	1.15
Fixing The Background.....	1.15
Chapter Two: The Elements	2.1
1. The Custom Brushes.....	2.2
Creating A Brush.....	2.2
Selecting Complex Shapes.....	2.3
The Background Color is Transparent.....	2.3

TABLE OF CONTENTS

A Brush is a Little Picture.....	2.4
Additional Features.....	2.4
Brush Handle.....	2.4
Perspective.....	2.5
Fast Feedback.....	2.5
2. The Screen.....	2.6
The Info Bar.....	2.6
Hiding the Tools and the Menu Bar.....	2.6
Magnifying and Zooming.....	2.7
Grids.....	2.7
Symmetry.....	2.9
The Pages.....	2.11
Switching Pages.....	2.11
Fixing the Background.....	2.12
Page Size.....	2.12
Screen Resolutions.....	2.13
3. The Palette.....	2.13
The Palette and Screen Formats.....	2.13
The Palette Window.....	2.14
4. The Tools.....	2.17
Modifying Tools.....	2.17
Built-In Brushes.....	2.17
The Airbrush.....	2.17
Straight Line and Curve Tools.....	2.17
Fill and Shape Tools.....	2.18
Brush Selector.....	2.20
Grid and Symmetry Tools.....	2.20

TABLE OF CONTENTS

5. The Painting Modes.....	2.20
6. Text.....	2.21
Chapter Three: Tutorials	3.1
1. Tutorial One: Modifying the Color Palette.....	3.2
Creating Your Own Palette.....	3.2
Creating Color Spreads and Ranges.....	3.6
Animation With Color Cycling.....	3.10
2. Tutorial Two: Logos Unlimited.....	3.12
Italicize.....	3.12
Bend.....	3.13
Resize.....	3.13
Changing Colors.....	3.14
Pattern Fill.....	3.15
Drop Shadows.....	3.16
Outlining the Logo.....	3.17
Gradient Fill.....	3.17
3. Tutorial Three: The World of Stencils.....	3.19
Distant Snowcaps.....	3.20
Sunrise in the Rockies.....	3.21
Cutting Some Z's.....	3.22
The Eyes Have It.....	3.23
Fixing The Background.....	3.23

TABLE OF CONTENTS

4. Tutorial Four: Putting Things in Perspective.....	3.25
An Area Rug.....	3.26
A Rug on the Ceiling.....	3.30
Cubism Revisited.....	3.30
A Row of Stately Homes.....	3.32
Another Point of View.....	3.33
Fixing Axes and Other Mysteries.....	3.33
City Planning.....	3.35

Chapter Four: Reference

1. Menu Items.....	4.1
Apple () Menu.....	4.2
File Menu.....	4.2
Edit Menu.....	4.4
Pict Menu.....	4.8
Mode Menu.....	4.12
Brush Menu.....	4.15
Color Menu.....	4.20
Font Menu.....	4.24
2. Toolbox.....	4.25
3. Keyboard Commands and Cursors.....	4.32
Brush Commands.....	4.32
Perspective Commands.....	4.32
Toolbox Commands.....	4.33
Palette Window Commands.....	4.34
Special Keys.....	4.34
Cursors.....	4.35

INTRODUCTION

Welcome to the world of computer-generated art. DeluxePaint is a graphics tool that can help you create works of art with an ease and precision that you may never have thought possible. After spending a little time with this manual, you will be able to create colorful graphics in a fraction of the time it would take you using more traditional techniques. You will learn how to create perspective effects, how to create and save your own custom brushes, how to mix your own color palette from a universe of 4096 possible colors, and how to create simple but effective on-screen animations, to name just a few of DeluxePaint's powerful features.

You don't have to read every word of this manual to become a proficient DeluxePaint user. We have organized the information so you can find what you need quickly and easily, and in a form best suited to your style. For example, you can learn by working through the tutorials in Chapter Three, or you can dive right in, and refer to Chapter Four, the reference section, for answering any questions that might arise. At the very least, however, you should read the section entitled "About This Manual" at the end of this Introduction, so you will know where to find the information you need. After that, you should feel free to use the manual as you see fit. Remember, however, that the more you read, the more you will get out of the program.

WHY COMPUTER GRAPHICS?

If you are new to computers or computer graphics, you may wonder what advantages DeluxePaint can provide over the more traditional media. To begin with, DeluxePaint does not pretend to be a substitute for every kind of graphic medium. After all, there will always be a place for fine oils on canvas, or for sculptures fashioned from Italian marble. What DeluxePaint can do, however, is help you create prototypes of your designs quickly and easily, letting you move from inspiration to execution in minutes instead of hours. Indeed, if Leonardo Da Vinci were alive today, he would probably be using DeluxePaint to design his masterpieces and inventions. And if so, his reasons would undoubtedly include the following:

First, DeluxePaint lets you do things that would be difficult, if not impossible, using traditional methods. For example, you can pick up any part of a picture and rotate it or flip it to create its mirror image. You can shrink and expand an image on the screen until it is just the right size, and then place it where it looks just right. Or you can create a mathematically precise color range just by specifying the beginning and ending shades and the number of steps in between.

Second, DeluxePaint is just like a word processor for graphic art. You can move images from one part of the picture to another, or you can copy an image and paste it in various places in your picture. You can create a forest of leaves just by drawing a single leaf and pasting it throughout your picture, or you can create clumps of leaves and paste *those* throughout your picture. In addition, you can make global changes to your artwork with ease. For example, if you decide that the blue border around a picture should be red, or that the flesh tones should contain a shade more tan, you can make the changes for the entire picture at one time, without having to do it element by element. Having created an element once, you don't need to create it a second time if all you want to do is change one or more of its characteristics.

INTRODUCTION

Third, because you can save all your work on disk, you can build up a library of images or clip art to use in future designs, without having to create everything from scratch each time. And because you can save versions of your picture as you go, you can always return to an earlier state of a design and pick it up from there, if you like. Finally, because you can print as many originals of a picture as you need, or make unlimited copies of your data disks with no degradation from one generation to the next, there need never be just one original of a picture to lose or spill coffee on.

Because of **DeluxePaint's** ability to take you beyond traditional media, you will find yourself developing a "new way of seeing," a new approach to graphic art. Beginning landscape artists are sometimes advised to view the scene upside down between their legs to eliminate any extraneous factors brought about by past associations. In a similar fashion (although you may not want to go so far as to stand on your head), you can save yourself hours of tedium by finding new and more efficient ways to create old effects. We will be exploring some of these techniques in Chapter Three, but after a little experience you will be able to come up with your own. **DeluxePaint** is the kind of software that invites experimentation, so you should feel free to play around with its various tools and effects. Remember, you can't hurt anything by experimenting with the software, and you may even discover an artistic side you never knew you had.

ABOUT THIS MANUAL

If you are new to computer graphics, we suggest you begin with Chapter One, "A Guided Tour," where you will be introduced to computer graphics and to *DeluxePaint's* fundamentals. There you will learn how to start the program and how to save and load your pictures. You will also learn about some of *DeluxePaint's* tools and techniques through simple exercises. If you are a beginning computer graphics artist, you will get the most out of the program by starting there.

If you already have some experience with graphics programs, you may want to begin with Chapter Two, "The Elements," which describes each of *DeluxePaint's* elements and explains how they interrelate. Each of the six elements (the Brushes, the Screen, the Palette, the Tools, the Painting Modes, and Text) work together to give you the power and versatility you need. There you will learn how to create your own brushes, how to mix your own palette from a universe of 4096 colors, how to customize tools, and how to mix text and graphics.

No matter what your level of expertise, Chapter Three, "Tutorials," will help you understand some of *DeluxePaint's* more complex features. These tutorials, designed with the assistance of professional *DeluxePaint* artists, concentrate on the more advanced uses of the program, such as the use of stencils, color mixing, perspective, and color cycling to create simple animation effects. The short time you invest working through these tutorials will pay off with interest when you become a proficient *DeluxePaint* artist.

If you are already familiar with *DeluxePaint*, or if you prefer to jump straight in without reading the documentation, Chapter Four, "Reference" can answer any questions you may have. Chapter Four documents every one of *DeluxePaint's* features by menu item, keyboard command, and tool icon. If you need a quick reference to any of *DeluxePaint's* features, you can find it there.

CHAPTER ONE: A GUIDED TOUR

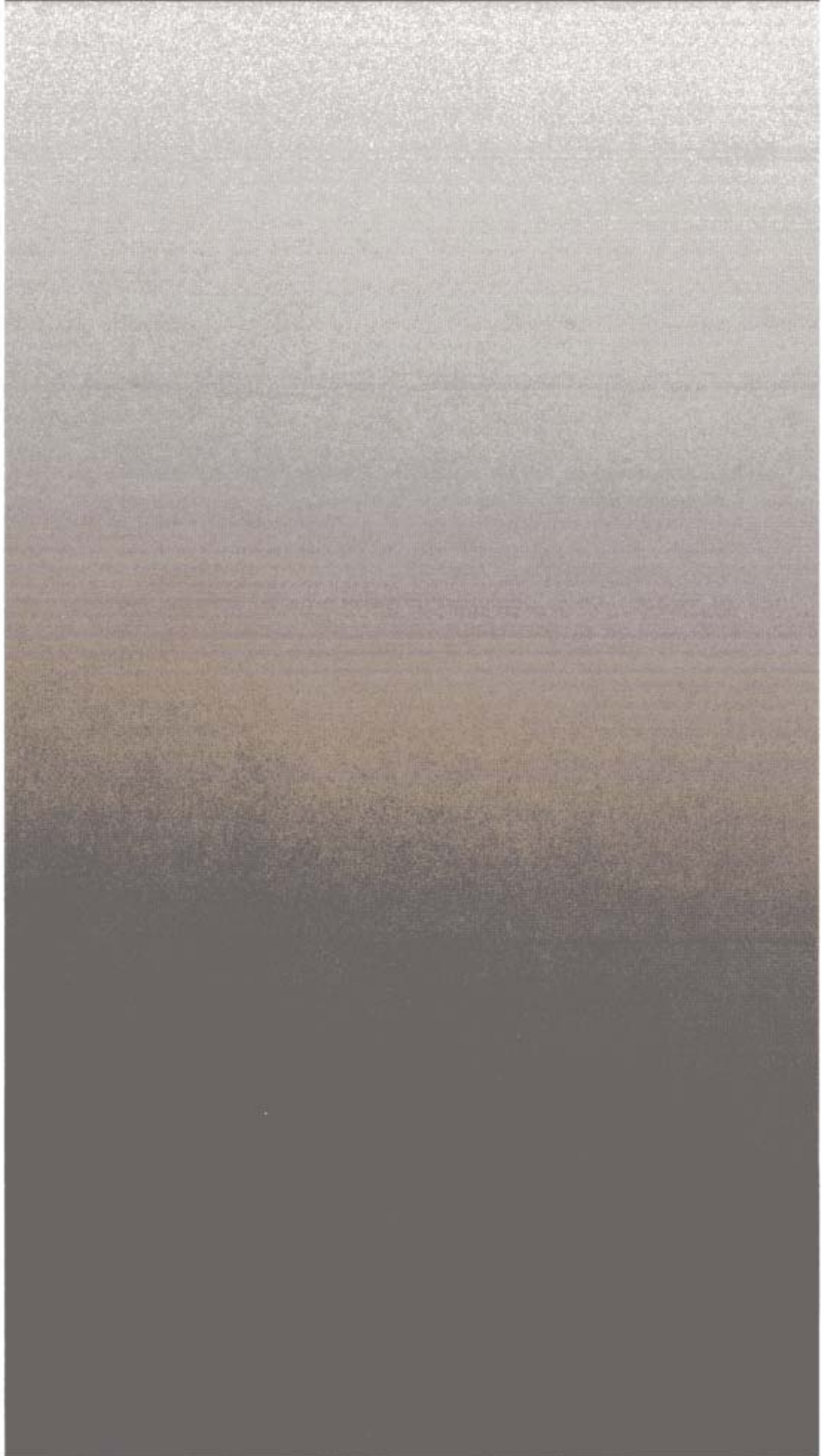

NOTES

DeluxePaint has much to offer any user, whether amateur or professional. If you are new to computer graphics and to *DeluxePaint*, this section will introduce you to the new graphic medium through simple step-by-step exercises. Here you'll learn how to create some simple designs using the built-in brushes and tools, and how to save a picture onto a data disk.

1 GETTING STARTED

SOFTWARE

Your **DeluxePaint** package contains two disks: 1) the program disk and 2) the bonus art disk. The program disk contains the instructions that tell the computer to behave like a graphics workstation. The bonus art disk contains *data* (a collection of sample images). These images are stored in a collection of folders. As we shall see shortly, you access these images by first selecting the folder, and then selecting the image. You'll use some of the images on the art disk as you work through the exercises in this manual.

HARDWARE

To use **DeluxePaint** you will need a IIGS, a monitor, one or two disk drives, and some initialized blank disks for saving your work. Finally, if you intend to print the files you create, you will need a printer. Consult the *Setting Up Your Apple IIGS* manual for information about connecting printers and other peripherals to the IIGS.

ORGANIZING YOUR DISKS

We assume that you already know how to initialize disks (also called formatting), copy disks, delete files, and move files from one disk to another. If not, we suggest you consult your IIGS documentation before going any further.

The first thing you should do is to make one or more working copies of your **DeluxePaint** disk to reduce the chance of anything happening to the original. You will also need to have one or more blank initialized data disks handy for saving your pictures, brushes, and stencils.

POWER UP

When you are ready to go, just follow these instructions:

- Insert your working copy of **DeluxePaint** and turn on your computer and monitor.

If you are using a two-drive system, put your working copy of the program in drive 1 and the original in the drive 2; after the program has loaded, you can eject the original and replace it with the **DeluxePaint** art disk or your own initialized data disk.

If you are using a single drive, you will receive a message asking you to insert the original disk. In that case, eject the copy and insert the original program disk. This process (which is known as the keydisk system because the original disk is the "key" that unlocks the system) allows **DeluxePaint** to read a code from the original disk to make sure that your copy is legitimate. When the drive stops spinning, eject the original and put it back into storage. You won't be needing it again for the rest of the session.

Starting **DeluxePaint** using a working copy saves wear and tear on your original program disk. However, if you prefer, you can start with the original disk in the drive, and replace it with the copy when the program has loaded.

When the program has finished loading, you'll see the **DeluxePaint** Painting Screen, with the painting area on the left, the Menu Bar on the top, and the Toolbox and Palette on the right. Figure 1.1 below also shows the optional Info Bar at the bottom of the screen. These screen components are described in the rest of this chapter and in Chapter 2.

Note: If you are using a Desktop with **DeluxePaint**, load **DeluxePaint** as you would any other IIGS application.

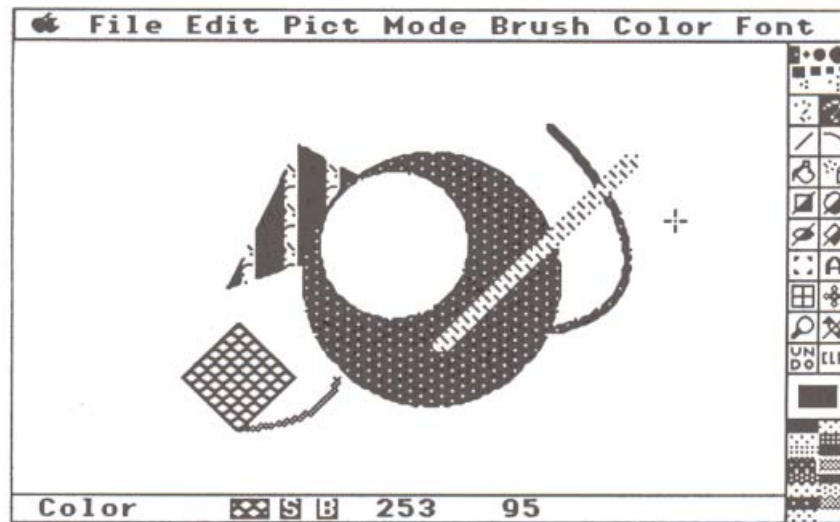

Figure 1.1. The Painting Screen

If this is your first time using *DeluxePaint*, we recommend you work through the following section, where you will learn how to use many of *DeluxePaint*'s tools and techniques.

2 GETTING ACQUAINTED

THE PALETTE

The Palette, the selection of 16 shades (two columns of eight shades each) at the bottom right-hand corner of the screen contains a representation of the color spectrum. (Sometimes we'll refer to this Palette as the main Palette.) Note that the painting area to the left of the Palette is white. This is the default *background* or *page* color, so called because it is the color of the imaginary "page" you are painting on. If you were to paint with the background color directly onto the background, it would appear to have no effect, as if you were putting white paint onto a white canvas. As we shall see in a moment, painting with the background color is a way of erasing an image on the page.

Directly above the Palette is the Color Indicator, a rectangle of one color inside a rectangle of another color. The inner rectangle shows the *foreground* or *brush* color — the palette color that your brush is currently loaded with. You can change this color at any time by clicking one of the other colors in the Palette with the mouse button. Try it. Move the pointer to one of the colors in the Palette and click. Note that the inner rectangle in the Color Indicator changes to show the new brush color. Click the other colors and see how the rectangle changes each time.

The outer rectangle in the Color Indicator shows the current background color. To change the background color, move the pointer to one of the colors in the Palette, hold down the Command key at the bottom left of the keyboard, and click with the mouse button. (In this manual, we will refer to this as Command-clicking.) Note that although the outer rectangle in the Color Indicator is now filled with the new background color, the painting area itself is still the old background color. This is because **DeluxePaint** assumes that you want to maintain the old background color as a "wash" over the new background color, and will keep it there until you clear the painting area. Try it now: Click the button labeled CLR directly above the Palette. This clears the screen of the old background color and replaces it with the new one.

Above the Palette is the Toolbox, which consists of a number of squares containing tools for creating your artwork (such as brushes of various widths and shapes that you draw with). Before you do anything else, let's get acquainted with one of the most important tools in the Toolbox, the Undo button. Located to the left of the CLR button, the Undo button will generally "undo" your last action, and is a hedge against potentially disastrous mouse clicks and key presses. Click Undo now to bring back the old background color. As a general rule, Undo reverses your last action, provided there has not been an intervening mouse click; so if you were to click CLR twice, for example, clicking Undo would not reverse the Clear command.

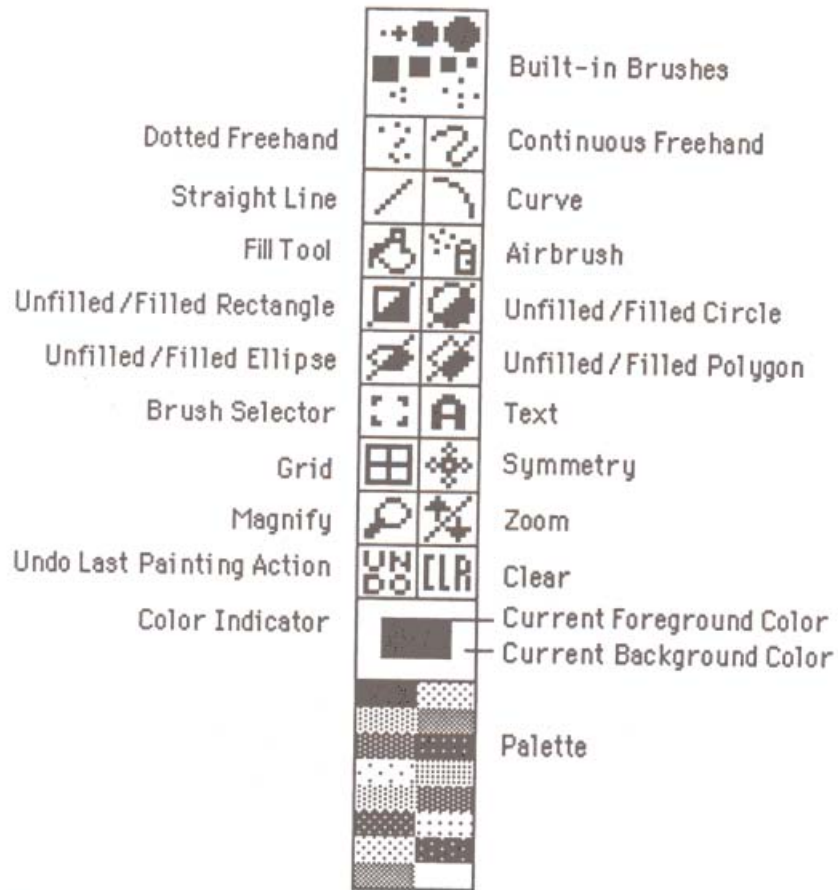

Figure 1.2 Toolbox and Palette

PAINTING WITH THE MOUSE

Now that we've seen how to choose colors from the Palette, let's put brush to "paper" and create our first drawing. Select a foreground and a background color by clicking and Command-clicking on the palette. Choose contrasting colors, such as blue for the foreground and yellow for the background. Click CLR to cover your page with the background color.

Move the pointer to the top right square in the Toolbox and click on the brush in the top right corner. Then move the pointer over to the page (where it turns into a crosshair) and, while holding down the mouse button, draw a figure on the screen. Don't worry about quality for the moment — a squiggly line or a rough circle will do. Now hold down the Command key and the mouse button and draw over your first figure. This has the effect of erasing your drawing, although what you are actually doing is painting over it with the background color. The rule here is simple: press the mouse button for painting with the brush color, and press the Command key and the mouse button for painting with the background color. Notice that this parallels the rule we noted above for selecting colors from the Palette: select the brush color by clicking with the mouse button and the background color by Command-clicking with the mouse button.

Practice drawing with the mouse for a while. Remember, you can always click Undo to reverse your last action, or CLR to clear the screen and start afresh. As soon as you're ready, let's move on to the next section, where we will be examining *DeluxePaint's* collection of brushes and tools.

THE TOOLBOX

THE BUILT-IN BRUSHES

DeluxePaint includes ten built-in brushes at the top of the Toolbox (refer to Figure 1.2): four round ones, four square ones, and two made up of a number of separate *pixels*. (Pixels, short for *picture elements*, are the small dots that make up the *DeluxePaint* screen. These are the building blocks with which you create all artwork.) To select a brush, move the pointer to one of the brush shapes and click with the mouse button. Note that clicking a brush shape highlights it, indicating that it is the currently selected brush. As we shall see, this convention applies to all the other tools as well.

With your new brush selected, go ahead and paint as before, pressing the mouse button to draw with the brush color and Command-pressing the mouse button to draw (or erase) with the background color. If you haven't already done so, try the three- and five-pixel brushes (the ones below the eight solid brushes) and see what they can do. In the next section we will be looking at the other drawing tools and seeing how they interact with the brushes.

THE TOOLS

The ten icons below the brushes (in two columns of five) control the drawing tools that work in combination with the brushes and the Palette. Because any brush can operate with any given tool, you have a wide variety of brush combinations at your fingertips. To cancel one tool, simply select another one. We'll describe the tools in order, moving left to right and top to bottom:

THE DOTTED FREEHAND TOOL allows fast freehand drawing. No matter how fast you draw with this tool, it keeps up with you, making it ideal for sketching out a shape quickly before concentrating on the intricate details. Note, however, that the faster you go, the bigger the gaps in your drawing. Once you have roughed out a shape with the Dotted Freehand tool, you can then refine your image using some of the other tools at your disposal. Try drawing with it using some of the other brushes to get a feeling for how it works.

THE CONTINUOUS FREEHAND TOOL. Because it produces unbroken lines, but may not keep up with you if you draw quickly, the Continuous Freehand tool is better suited for slower, more painstaking drawing. Note, however, that the smaller the brush, the better it is at keeping up. Try it with different brushes and see how brush size and shape affect speed.

THE STRAIGHT LINE TOOL lets you draw straight lines by clicking and dragging the mouse. Here's how it works: First, click on the Straight Line tool to activate it, and then move the crosshair to the point on the page where you would like the line to begin. Now press the mouse button to anchor the line at that point, and, while holding the button down, drag the mouse to the point where you want the line to end. When you release the button, you have a straight line in your selected brush color and brush size. Note that you can also draw straight lines with the background color by holding down the Command key as you press the mouse button.

THE CURVE TOOL draws curved lines between two points in the painting area. It works just like the Straight Line tool except that it requires an additional mouse click to complete the process. Here's how: Anchor the curve by pressing the mouse button, hold it down, drag it to the point where you want the curve to end, and release the button. Now, as you move the mouse away from the end points, you'll

notice that the line is still "active," and will curve to follow the crosshair wherever you drag it. As soon as the curve is the right shape, click the mouse button to freeze it at that position. With a little practice, you'll be able to make curves of any shape and size. Try joining a series of curves to make flowing shapes with changes in curve direction.

THE FILL TOOL fills any enclosed shape with the current foreground or background color. To use the Fill tool, click the icon, move the cursor (which now looks like a paintcan) to an enclosed shape, and click again. You can fill the shape with the current foreground color by clicking the mouse button, and with the current background color by Command-clicking the mouse button. Note that the Fill tool fills all the way to the boundaries of an *enclosed* shape. If the shape is not completely enclosed (that is, if there is a hole in its perimeter), the paint will "leak" through and fill the entire page. If this ever happens, press the Spacebar to stop the filling process and remove the fill you just inserted. (The Spacebar nips any ongoing process in the bud and returns the screen to its pre-command state.)

It is important to realize which part of the paintcan cursor is the "spout" — that is, which part needs to be within the enclosed shape when you give the Fill command. This becomes important if you need to fill a shape smaller than the paintcan cursor itself. The paintcan's spout is the bottom of the splash pouring from the can. With careful maneuvering, you can fill a space as small as one pixel by placing the spout on that space.

THE AIRBRUSH TOOL is a full-featured airbrush with adjustable tips and nozzles. By using the Airbrush in combination with the different brushes, you can create a variety of effects, ranging from a fine one-pixel spray to a coarse spray made with the big brushes. In the following chapter we will see how to adjust the size (radius) of the spray, but for now let's try it as is. Click the Airbrush icon, and then try painting with it using the various brushes. Try it with the three- and five-pixel brushes, and then try it with the big brushes. Note that, just like a regular airbrush, if you keep the mouse button pressed without moving the mouse, the paint continues to build up in one spot.

THE RECTANGLE TOOL lets you draw squares or rectangles, either unfilled or filled, with the current brush or background color. Note that the Rectangle tool icon has a diagonal line running from its top right to its bottom left corner. This is because it is actually two tools in one — the top left one creates unfilled shapes, while the bottom right one creates shapes filled with the current foreground or background color.

Let's try making a few rectangles. Click the top left half of the icon. Move the pointer onto the painting area (where it changes into a large crosshair), press the mouse button to anchor one of the corners of the rectangle, and, while holding the mouse button down, drag the mouse away from the anchor point. You can drag the mouse down and to the right (in which case the first button press anchors the rectangle's top left corner), or in any other direction you wish. In any case, the rectangle is completed as soon as you release the button. Note that it is unfilled and bordered by the current foreground color. You can also create an unfilled rectangle bordered by the background color: First, Command-click another color on the Palette, then make a rectangle by holding down the Command key while anchoring and dragging the mouse as before.

To create a filled rectangle, click the lower right part of the Rectangle icon and repeat the above procedure. This time, the rectangles you create will be filled with either the foreground or the background color, depending on whether you press only the mouse button or the Command key and the mouse button when you create the rectangle. Here are some other tricks you can try with rectangles:

Constraining. If you hold down the Shift key as you draw, you can constrain the rectangle so that it is a square. This allows you to draw squares easily. You can also use the Shift key with the Straight Line and Polygon tools to constrain lines to horizontal and vertical lines.

Note: Because IIGS pixels are not perfectly square, "constrained" rectangles will not appear square on the screen. Depending on your printer, they might be square when printed, though. You can compensate for the problem on the screen by selecting Square Aspect from the Edit menu. See discussion in the Reference section under Edit Menu.

Leaving Traces. Holding down the CTRL key while using the Rectangle tool paints *traces* as you draw. In other words, as you drag the mouse to paint a large rectangle, **DeluxePaint** also paints the intermediate rectangles. You can also use CTRL to create traces with these other tools: Straight Line, Curve, Circle, Ellipse, and Polygon.

THE CIRCLE TOOL works like the Rectangle tool, above: Click the top left part of the icon to get an unfilled shape, or the bottom right to get a filled shape. Move to the painting area, then press and drag with the mouse button to create a circle with the current foreground color, or hold down the Command key and press and drag with the mouse button to create a circle bordered (or filled) with the current background color. When you release the button, **DeluxePaint** draws your circle. (*Note:* Because IIGS pixels are not perfectly square, circles will not appear perfectly round on the screen. You can compensate for this problem by selecting Square Aspect from the Edit menu.)

THE ELLIPSE TOOL works just like the Circle tool, except that it is still "active" after you release the mouse button. First you size your ellipse; then (if desired) you rotate it. Try it. Click the icon with the mouse button (remember, top left for unfilled, and bottom right for a filled shape), move the pointer to the painting area, and draw an ellipse by pressing the button and dragging the mouse. Now release the button. Note that even though you have released the button, the ellipse continues to change shape as you drag the mouse around. By doing so, you can make the ellipse any shape you like. As soon as it is just the right shape and size, click the mouse button again to draw your ellipse. Or, to change the orientation of your ellipse, press and hold the button down instead of clicking it, rotate the ellipse about its center, and release the button when the orientation is just right. **DeluxePaint** then draws your ellipse, and the small crosshair changes into the large crosshair to let you know that it is ready for your next command.

THE POLYGON TOOL lets you keep drawing straight lines until you have created a closed figure. Here's how it works: Click the Polygon tool, move the crosshair into the painting area, and click the button once to anchor the starting point of your polygon, and then a second time to complete the first line, as if you were using the Straight Line tool. This time, however, you will notice that your crosshair is still connected to the first line by a second straight line. Click the button

again to finish the second line, and so on until you have completed your polygon. The polygon is completed as soon as you click the button with the crosshair on your starting point. If you are creating a filled polygon, it will be filled with the current foreground color if you complete the figure with a click, and the current background color if you complete it with a Command-click.

Because it can sometimes be a little tricky to click on the exact pixel you started with, you can complete a polygon at any time by pressing the Spacebar. This automatically connects the last anchored point to the point of origin and, if it is a filled polygon, fills it with the current foreground color. Try drawing some five-pointed stars with the filled Polygon tool and see what happens.

ANYTHING CAN BE A BRUSH

We'll skip over the rest of the tools for now, except one. (We'll be covering the remaining tools in Chapter Two.) The icon just below the Ellipse is the **Brush Selector**, a special tool that is an essential part of *DeluxePaint's* versatility. With the Brush Selector, *anything can be a brush* — any piece of artwork or text you put on the screen. To see it in action, click the icon, then move the cursor over to the painting area. Notice that your cursor is now a large crosshair that reaches to the edges of the screen.

Select one of the stars you made earlier by putting the center of the crosshair to the upper left of the star. Then, while holding down the mouse button, drag the cursor to the lower right of the star, as if you were using the Rectangle tool to enclose the star in a box. When you release the mouse button, the cursor now has a copy of the star attached to it. This second star is your new brush! To stamp a star in a new location, click the mouse button. There's no need to stop with one — go ahead and star-spangle the screen. We will be covering this powerful feature in greater depth in Chapter Two. For now, however, there is one aspect of brush selection you should be aware of: if any parts of your brush consist of the current background color, those parts will be transparent. In other words, whenever you pick up a brush, the background color in the brush will be invisible, provided that color is the currently selected background color.

Let's try one more trick. Click the Brush Selector again and select a star from the painting area, but this time hold down the Command key and press the mouse button to drag the crosshair over the star. Unlike the last exercise, which yielded two stars — one unmoving original, plus the one on your brush — this time you are picking up and moving just the one star. While the first feature lets you copy and move anything on the screen, the second lets you move images from one part of the screen to another, while leaving no trace behind.

To change from a custom brush, create another custom brush or click a built-in brush at the top of the Toolbox.

3 GETTING GOING

SAVING YOUR WORK

Before we move on to the next chapter, where we'll be looking at *DeluxePaint*'s basic elements, let's see how to save and load the pictures (or "files") you create. First, let's learn how to save a file, just in case you feel that the recent exercises were a first step towards a masterpiece. Even if you don't feel quite this way about your creations yet, you might want to follow along for future reference.

DeluxePaint provides access to hundreds of additional features that are not constantly visible like the Palette and the Toolbox. These features (which include loading and saving, among others) are available through a series of pull-down menus in the Menu Bar at the top of the screen.

As you move your pointer from left to right along the Menu Bar (while holding down the mouse button), one after another of the menus extends down, each one displaying its selection of options. We will be looking at each menu item in detail later, but for now we just need to use the same options on the File menu. So, move the pointer to the word File at the left of the Menu Bar and hold down the mouse button to produce the File menu options. With the button still held down, move the pointer down to Save Picture, the second item on the list of options, and release the button. This results in a Save Picture Dialog Box (see Figure 1.3). It is through the Save Picture Dialog Box that you provide *DeluxePaint* with the information it needs to save your files.

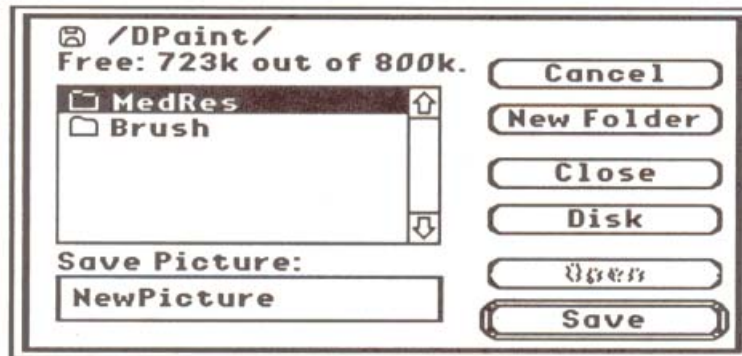

Figure 1.3. Save Picture Dialog Box

At the top of the dialog box is the name of your disk and the amount of storage space remaining on it. Below that is a list of folder names and filenames. You can scroll through these names (not all of them are always visible at one time) by dragging the *scroll box* up and down. (The scroll box is the white rectangle within the *scroll bar*, the vertical column to the right of the filenames.) Just point to the scroll box, press the mouse button, and drag it up or down. As soon as you release the button, new names will appear in the dialog box. You can also scroll through the names one at a time by clicking the up and down arrows at the top and bottom of the scroll bar.

Now is your chance to save your current creation as a new file. If you are using only one disk drive, eject your working copy of the DeluxePaint disk and replace it with a blank initialized disk. Then click in the Save Picture box, type the name you have chosen for your new file, and click the Save button at the bottom right of the dialog box. (To save a file in a folder, first click on the folder and click the Open button to open. Then type a new filename in the Save Picture box and click the Save button.)

If you are using two drives, save your picture as follows: Put the data disk in drive 2, click the Disk button on the right of the dialog box until you get to the drive 2 disk, click in the Save Picture box, and type the filename. Click the Save button to complete the process.

The next time you save this file (it's a good idea to save work in progress every 15 minutes or so, so that a power failure or other mishap doesn't turn hours of work into a bitter memory), the Save Picture Dialog Box uses this same information, which means you won't need to type anything more unless you want to change the filename. You might want to do this to save it under another name, if you want to save each version as a separate file. In that case, you would click the Save Picture box as before, delete the old filename (or those parts you wish to change) and type the new name. Or you could just keep adding suffixes, such as 1, 2, 3, to signify succeeding versions.

LOADING A PICTURE

Now that we've seen how to save a file, let's see how to load one of the pictures on your disk. Let's load the one called *Seascape*. First, move the pointer up to the Menu Bar and to the left to the File menu. Press the mouse button to extend the menu, and then select Load Picture. This time you are presented with the Load Picture Dialog Box (see Figure 1.4).

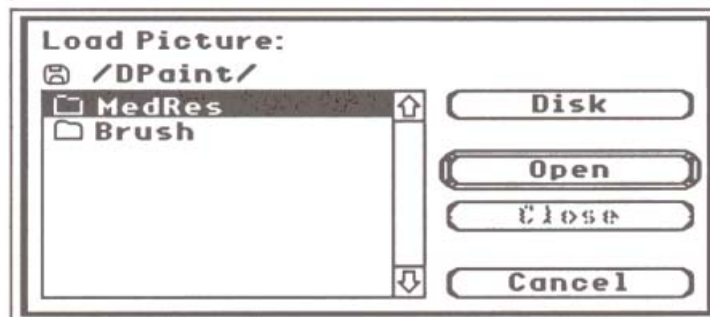

Figure 1.4. Load Picture Dialog Box

Note that the Load Picture Dialog Box is similar to the Save Picture Dialog Box. If you're using only one disk drive, make sure you have inserted the DeluxePaint art disk in your drive. If you're using two drives, click the Disk button until you get to the drive containing your DeluxePaint art disk. When you see the name of the art disk at the top of the dialog box, scroll to the folder or file you're looking for. Let's load the sample file *Seascape*: First open its folder (Med.Res) by clicking the folder name and then the Open button. (You can also open a folder or file simply by double clicking the name.) Then click the filename *Seascape* and the Open button. The disk drive will spin for a few moments, and then the picture will appear on the screen. (To close an open folder and return to the previous list of files and folders, click the Close button.)

NIGHT AND DAY

Take a few moments to examine the picture carefully. Note, for example, that the palette is different from the one we were using before. This is because the new picture comes with its own palette, which supersedes the old one. You can revert to the default palette at any time through a simple menu selection. Let's try it now and see what happens. Pull down the Color menu and drag the pointer down to Default Palette, then release the button.

Did you see what happened? The new palette was replaced by the default palette, making the picture change from night to day! If you want to restore the original palette, return to the Color menu and drag down to Restore Palette. When you release the button, the palette reverts to the original. This is just one example of the many ways you can make global (and dramatic) changes to a picture with just one action.

FIXING THE BACKGROUND

Let's try one more trick before we move on to the next section. Click the CLR button once to clear the screen, and then click Undo to restore the picture. (If you clicked CLR twice, Undo will not work to restore the picture. You will need to load it again.) Now open the Pict menu, drag down to Fix Background, and release the button.

What you have just done is remarkably simple, and yet remarkably powerful. You have fixed the picture onto the background so that it cannot be removed. Try it. Click CLR as you did before and see what happens. That's right — nothing. The picture is fixed, which means you can draw over it any way you like, and then click CLR to restore it to its original form. Go ahead, select a thick brush and draw all over it. Do it with the airbrush if you like. Then click CLR for the easiest art restoration job ever.

Note that you can continue fixing the background each step of the way, with each "fix" stamping the entire picture into the background. This way you can erase everything you did since the last fix with a single mouse click. And you can "unfix" the background just as easily as you fixed it: just go to the Pict menu and drag down to Free Background. This restores everything back to normal, so that clicking CLR clears the entire picture.

We will be looking more closely at this feature in the next section when we look at custom brushes and the way they interact with the background. Meanwhile, feel free to experiment further with this feature. Art restorers should have it so easy.

CHAPTER TWO: THE ELEMENTS





NOTES



CHAPTER TWO: THE ELEMENTS

In this chapter we examine the fundamental "elements" that make up DeluxePaint. If you have some experience with computer graphics software, you may want to use this chapter to learn how DeluxePaint handles features you may have encountered in other programs. As with any other part of this manual, however, you should feel free to read sections in any order you wish.

We have classified the elements as follows:

The Custom Brushes examines DeluxePaint's custom brush capabilities. This part looks at the various techniques available for modifying a brush, such as resizing, flipping, and, by entering Perspective mode, rotating it about its three spatial axes.

The Screen deals with all those techniques that affect the entire DeluxePaint screen, such as switching pages, magnifying and zooming, gridding, symmetry, screen resolutions.

The Palette looks at DeluxePaint's color mixing and color cycling capabilities, and examines how color availability relates to screen resolution.

The Tools looks at advanced tool techniques, and shows how to customize some of the standard tools to create just the right tool for the job.

The Painting Modes deals with the various ways you can affect paint once it is already on the page, such as smearing, blending, or smoothing it to give you special effects.

Text shows how to use DeluxePaint as an elementary word processor, showing how to select fonts, how to enter text, and how to move it about the page.

Many of the techniques discussed in this chapter are also covered in the tutorials in Chapter Three. If you prefer to learn by doing, you may want to work through the tutorials first, and then refer to the relevant parts of this chapter if you need more information. Or you may want to read this chapter first to understand how DeluxePaint is structured, and then try some of the tutorials to see how it works in practice.

1 THE CUSTOM BRUSHES

As we saw in the Guided Tour in Chapter One, *DeluxePaint*'s "anything can be a brush" feature lets you select any image on the screen and use it as a brush. Thus, you can keep a selection of images on your spare page (the second page that is available in any *DeluxePaint* painting) and move the images over to the main page by picking them up as brushes. In addition, you can load and save brushes as separate files in the same way you load and save pictures.

CREATING A BRUSH

To create a brush out of an on-screen image, click the Brush Selector (the tool to the left of the Text tool) and then drag the large crosshair to form a rectangle around the image. When you release the mouse button, an exact copy of the image is attached to your arrow cursor. You can now paint with your new brush just as you would with any of the built-in brushes.

As we saw in the Guided Tour, when you drag the Brush Selector rectangle around an on-screen image using the mouse button, *DeluxePaint* makes a duplicate of the image and attaches it to the arrow cursor, while leaving the original image in place on the page. We also saw that if you hold down the Command key and press the mouse button to surround the image, the image itself becomes the brush, as if the original image had been lifted up off the page. This technique provides an ideal method for picking up objects and moving them around the page as you experiment with different compositions. In particular, if you use the Fix Background menu option (which we also covered in the Guided Tour) and then create images on top of the fixed background, you can lift any of these images off the background using the Command key and mouse button. *DeluxePaint* "remembers" those parts of a fixed background that are covered by unfixed shapes, so that you can move the shapes around the page and uncover the previously hidden background.

SELECTING COMPLEX SHAPES

As we saw earlier, clicking the Brush Selector once with the mouse button lets you draw a rectangle around any image on the page. Clicking the Brush Selector a second time lets you "corral" any image, thereby letting you pick up shapes from a crowded background. To corral an image, move the arrow cursor and click around the shape you wish to define, just as if you were describing a polygon around it with the Polygon tool (see "The Toolbox" in The Guided Tour). As soon as you complete the selection polygon, the complex shape becomes your new brush. To corral and *duplicate* the shape, create your selection polygon by dragging and clicking the mouse button. To corral the shape and *pick it up* off the background, create your selection polygon by dragging and Command-clicking the mouse button. Note also that this corraling function works just like the Polygon tool in one more important respect: pressing the Spacebar completes the selection polygon for you, so you don't have to search for the starting pixel in order to complete it.

THE BACKGROUND COLOR IS TRANSPARENT

When you create a custom brush (with either method described above), you will notice that any part of the brush which matches the current background color appears transparent. For example, if you pick up a round object sitting on the background color, you pick up part of the background as well (because the Brush Selector picks up rectangular shapes), but when you move your new brush over to a contrasting object, the brush contours will appear round and not rectangular. This is because *DeluxePaint* treats the current background as transparent. Whenever you are using a brush and want a color in the brush to be transparent, simply select that color as the current background color (it will be displayed in the Color Indicator). Change background colors to make a different brush color transparent. This feature lets you create a brush out of a complex image (such as intricate lace, for example) and then see through it to other objects behind the brush.

A BRUSH IS A LITTLE PICTURE

Because a brush can be as complex as you like, you can treat brushes just like full pictures. When you load a saved brush, it comes equipped with its own palette, the one that was in effect when the brush was first saved. If the current picture is using a palette different from that of the newly-loaded brush, you can change the current palette to the brush's palette by selecting Use Brush Palette from the Color menu. On the other hand, if you want to use the newly-loaded brush with the current palette, select Remap Brush from the Color menu. The Brush menu lets you resize and reshape brushes in various ways. See Tutorial Two for a series of exercises in modifying colors and shapes of brushes.

Your *DeluxePaint* disk contains a number of saved brushes, in addition to the ones used in the tutorials. To load a brush, select Load Brush from the File menu. This brings up a Load Brush Dialog Box, similar to the Load Picture Dialog Box we used when we loaded a picture in the Guided Tour (see Chapter One). Make sure the name of the *DeluxePaint* art disk appears at the top of the dialog box. Open the Brush folder and experiment with some of the saved brushes. Select Use Brush Palette whenever you load a brush to ensure that you are seeing it as it was when it was saved. Load the brush called *Bobsled*, for example, and try drawing with it. You'll soon realize why it's called *Bobsled*. You might also try the one called *Fireworks*, but this time select Multi-Cycle and Cycle from the Mode menu, and then press the Tab key before you start drawing with it. *Fireworks* comes complete with color cycling information, and is a spectacular example of the power of this feature. See Tutorial One for more demonstrations of color cycling.

ADDITIONAL FEATURES

The following are some additional features relating to custom brushes:

BRUSH HANDLE: This feature, which is available from the Edit menu, allows you to specify whether your arrow cursor will sit at the center of your custom brush, or at one of its corners. In the default setting (when the Brush Handle is not checked on the Edit menu), the arrow cursor sits at the center of the custom brush and you can hold the brush directly by its center. When you select Brush Handle from the

Edit menu and create a brush, you hold your brush by a "handle" on one of its corners. If you create your brush by dragging downward from upper left to lower right, the brush handle will attach itself to the lower right-hand corner, whereas if you create the brush by dragging from lower right to upper left, the handle will attach itself to the upper left-hand corner. The rule is simple: the brush handle attaches itself to the *ending* corner in the brush creation process. The Brush Handle option becomes important when you enter Perspective mode (see below), because you can rotate a brush about its center or its handle.

PERSPECTIVE: DeluxePaint's Perspective option (available through the Brush menu) lets you rotate a custom brush about any of the three axes of three-dimensional space to define a plane of operation, and then work within that plane to create perspective effects. Here's a quick overview of how to use Perspective: You pick up a custom brush and select Perspective from the Brush menu. This turns your brush into the Perspective Brush outline, a rectangle frame with a cross in the middle. Using Perspective commands described in the Reference section, you can manipulate the Perspective Brush outline by rotating it about its three axes or by moving it closer to or further away from the observer. Once you define the plane of operation, moving the mouse moves the Perspective Brush outline along that plane, in three-dimensional space. Clicking the mouse button places a full-color, perspective version of the original brush onto the defined plane.

Perspective is the subject of the fourth tutorial in the following chapter. To get the most out of this special feature, we recommend you work through the exercises in that tutorial. You can also consult Chapter Four, the Reference section, for more information on perspective.

FAST FEEDBACK: This feature, which is available from the Edit menu, allows you to draw lines, filled shapes, or unfilled shapes with a complex brush, but with faster feedback. With Fast Feedback selected, when you draw a line or shape with a custom brush, all you see is a one-pixel line or outline until you finish drawing, at which point your line or shape is repainted with the current brush. When Fast Feedback is selected, a check appears next to it on the menu.

2 THE SCREEN

Some of **DeluxePaint**'s features affect the entire screen, while others, such as the tools and the brushes, affect the screen selectively. This section considers those features that have a screen-wide effect.

INFO BAR

The Info Bar at the bottom of the screen displays information about your status. Select Info Bar from the Edit menu or press 9 (use the number key on the main keyboard, not the keypad). The Info Bar shows you the current Mode setting (such as Matte), the current pattern, gradient, or perspective fill, an S if you have a stencil on, and a B if your background is fixed. If you have selected Coordinates from the Edit menu, the Info Bar shows the x and y coordinates of your brush location. If you're in Perspective mode (and Coordinates is turned off), the Info Bar also shows the amount of rotation about your three axes.

To hide the Info Bar again, select Info Bar from the Edit menu or press 9.

HIDING THE TOOLS AND THE MENU BAR

DeluxePaint lets you paint on the entire screen, even under the Toolbox/Palette and the Menu Bar. To clear these from the page, press the 0 (zero) key (use the number key on the main keyboard). Press the same key a second time to bring these back.

You can access the tools, even with the Toolbox hidden, through the keyboard equivalents. See the Reference section of this manual or your Reference Card for a list of keyboard commands.

MAGNIFYING AND ZOOMING

You can magnify any section of your work, and view it alongside the standard-sized image. To magnify a section of your work, click the Magnify icon (the one that looks like a magnifying glass, above the Undo icon). When you move the cursor onto the page, it becomes a rectangular outline. Move the outline to the part of the image you want to magnify, and click the mouse button. The part of the image included in the rectangle now appears magnified on the right part of the screen. The left part of the screen shows the image in its original, unmagnified form. Another way to enter the Magnify mode is to move your cursor to the area you want to magnify, and press the **m** key.

You can now carry out any functions on either side of the screen using any of the tools in the Toolbox. Thus, you can draw circles and squares, fill in shapes using the Fill tool, and use any of the brushes normally available to you. Using the four arrow keys, you can move the image around under the "magnifying glass." In addition, by pointing your cursor anywhere on the unmagnified or magnified portion of the screen and pressing the **n** key, you can center that part of the picture in the magnified area.

Once you have magnified a part of your picture, you can increase or decrease the amount of magnification by using the Zoom function (the Zoom icon is the one to the right of the Magnify icon). Click the top left half of the Zoom icon (the Up Arrow) to increase the magnification, and click the bottom right half of the Zoom icon (the Down Arrow) to reduce the magnification. *DeluxePaint's* Magnify and Zoom tools let you carry out precision work on your pictures by magnifying each pixel up to 16 times its original size.

To quit Magnify mode when you have the magnified area on the screen, click the Magnify icon a second time.

GRIDS

The Grid lets you apply paint on the page in accordance with an invisible grid. The Grid also restricts your drawing tools to the grid points. As an example of drawing on a grid, click the Grid icon (directly above the Magnify icon) and then click the Dotted Freehand tool. With Grid and the Dotted Freehand tool selected, you can paint only on the points of the grid, making it easy to fill the screen with a polka-dot pattern, for example (we shall see other methods for pattern design later).

Grid works with all tools except the Continuous Freehand tool. For example, if you use Grid with the Rectangle tool, you can put down the corners of your rectangles only at grid points.

You can also control the spacing between the grid points. Command-click the Grid icon to bring up the Grid Dialog Box (see Figure 2.1). You can now set the spacing for the X and the Y coordinates to match the dimensions of your brush by clicking From Brush. Or you can type the actual spacing in the X-Spacing and Y-Spacing boxes. Note that the spacing is calibrated in pixels. To enter a new value, click anywhere in the calibration box, delete the existing value, and then type in the new value. When you are satisfied with the new values, click OK. If you want to retain the old values and return to your work without making a change, click Cancel.

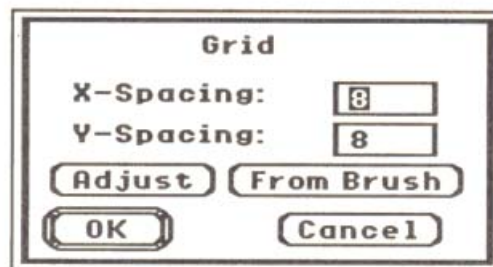

Figure 2.1. Grid Dialog Box

You can also recalibrate the gridding by using a visual method (as opposed to the above numerical method). If you click Adjust in the Grid Dialog Box, you will return to the painting screen with a cursor that looks like a 4 x 4 matrix. This matrix represents the current grid values in graphic form. To *resize* the grid visually (and hence change the x and y grid values), press and hold down the mouse button, drag the mouse until the matrix is the desired size and shape, and then release the button. The new grid is based on this matrix. You can also *reposition* the points of the grid using Adjust: Move the matrix so that its cells are in the desired position and click the mouse button. Note: To set a grid point at a specific coordinate, first turn on the Info Bar and Coordinates (on the Edit Menu).

If you have the grid on and plan to pick up an image as a brush to create a continuous pattern, you might want to select Excl Brush before you pick up the brush in order to eliminate a one-pixel border on the right and bottom edges of the image. (For details, see Excl Brush under the Edit Menu in the Reference section.)

If you are in Perspective mode and you Command-click the Grid icon, the resulting dialog box lets you adjust the spacing for the third dimension as well (Z-spacing). The dialog box also lets you specify the angle of rotation of your brush about the three axes (called the Angle Step). See the discussion of the Grid tool in the Reference section for more information.

The Grid tool is useful for precise cursor placement of images and makes it easy to create repeating patterns, parallel lines, and other repetitive designs. To turn off the Grid tool, click the icon a second time.

SYMMETRY

The Symmetry tool lets you paint symmetrically over the entire page at the same time. To paint symmetrically, click the Symmetry tool (the one to the right of the Grid tool). With Symmetry selected, your brush is made up of a number of mirror images of itself. As you move the brush around, all the mirror images move as well, producing an effect much like that of a kaleidoscope. When you paint in Symmetry mode, you are laying down a number of identical mirror images about a fixed origin. In all cases except the Dotted and Continuous Freehand tools, the mirror images are drawn *after* you release the mouse button. With the Dotted and Continuous Freehand tools, all the images are drawn at the same time.

To change the Symmetry tool's values, Command-click the Symmetry icon. This brings up the Symmetry Dialog Box (see Figure 2.2).

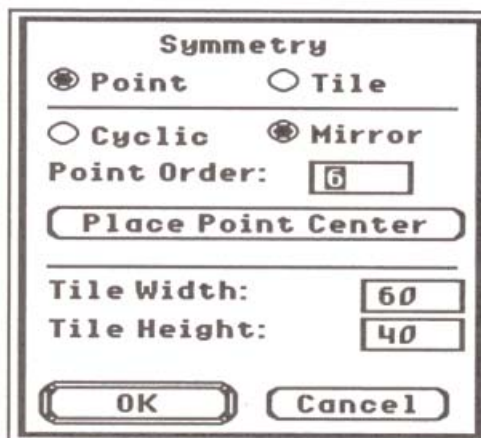

Figure 2.2. Symmetry Dialog Box

Point means that the symmetry occurs about a single central point (which you can define). The Point Order box specifies the order of the symmetry, that is, how many times the basic image is repeated about the central point. To change the order, click in the Order box, delete the existing value, and type in the new value. You can use any order up to 40. Place Point Center lets you position the central point of your symmetrical pattern. To reposition the central point, click Place Point Center, move the large crosshair to the new location, and click the mouse button. Subsequent symmetrical drawing will be centered on the new location.

If you select Point Symmetry, you have two options — Mirror or Cyclic. Mirror means that each brush head has a related twin that mirrors its actions. Try using Mirror: Select Point and Mirror, change Point Order to 4, click OK, and draw a small rectangle on the screen. Note that the result is a total of 8 rectangles on your page.

Cyclic, like Mirror, lets you draw about a point with a number of brushes (also determined by Point Order), but the effect is different from the Mirror option. In Mirror, each brush has a twin: if your order is four, you have eight drawing points on the page, with the two points in each pair reflecting each other's actions. In the Cyclic mode, there are no pairs: If your order is four, there are four brushes on the page. The pattern produced by each brush is not itself symmetrical because it does not create a mirror image of itself as you draw. Try it and see.

Tile lets you draw with a number of brushes at the same time, but without mirroring them about a central point. Instead, Tile creates a number of images on a grid, making it easy to create groups of identical images in a regular pattern. To draw in Tile mode, click Tile in the Symmetry Dialog Box. You can then specify the distance in pixels between each point, for both the x-axis (width) and the y-axis (height). Whenever you select the Symmetry tool from then on (until you change it again), you will be painting with a series of regularly-spaced brushes. Because Tile lets you create an entire pattern just by drawing one of its elements, it is an ideal tool for textile designers. Together with Pattern Fill (discussed below), Tile can make a textile designer's life considerably easier. Try using Tile: Select Tile and draw a small rectangle on the screen. Note the regular-spaced pattern of rectangles that results.

Finally, as with any other dialog box, click OK to use the current setting and return to your picture, or Cancel to return to your picture without effecting any change. To turn off Symmetry, click the icon a second time.

THE PAGES

DeluxePaint gives you two separate and relatively independent pages to work with. You can use one of the pages for creating background images, and the other for creating foreground images. You can then move parts from one page to the other, or within each page until the composition is just right. As we shall see in a moment, the two pages are not entirely independent. For one thing, they share a common Palette, almost as if they were the same picture.

SWITCHING PAGES

When you first open a new file or load a picture from disk, **DeluxePaint** opens one of the two pages. To move from one page to the other, press the **j** key, or select Spare Page from the Pict menu. When you do, you will notice that the Palette you were using in the first page follows you to the second page. This means that if you modify the Palette for one page and then switch to the other page, you end up modifying the second page's Palette as well. Note, however, that although the two pages share the same palette, you can have a different background color on each page. (Note: If your two background colors are different, your brush's transparent areas will be different if you move it from one page to the other.)

In addition, because the Toolbox is not really part of the page (but actually sits "above" it), whatever tools you had selected before you switched will still be selected after you switch pages. This way, you can retain the same tool settings, giving you continuity as you work. Note that the Fix Background option and the Stencil options do not carry over from one page to the other. See the following section for information on fixing the background, and Tutorial Three in the next chapter for exercises involving the Fix Background and Stencil features.

FIXING THE BACKGROUND

As we saw in the Guided Tour, the Fix Background option (from the Pict menu) lets you fix whatever is currently on the page as a background. When you have a picture fixed as a background, you can return to it at any time just by clicking CLR in the Toolbox. This is because CLR always clears to the background (which under normal circumstances is simply the background color), so when you have a picture fixed as a background, CLR clears to that. This means that you can try daring innovations on a fixed background, and then return to the original picture with just the click of a mouse. Or you can paint while holding down the Command key and the mouse button to erase anything you have added since the fix.

In addition, you can pick up any part of the recent additions to a fixed background with the Brush Selector (see Custom Brushes, above) and reposition them anywhere on the page. Note, however, that if you fix the background and then add more paint, you can only pick up those portions of the newly-added paint that are not the same color as the current background color.

PAGE SIZE

The Page Size option on the Pict menu lets you specify the finished size of your painting (called the page size). When the Set Page Size Dialog Box appears (refer to Figure 4.2), you can select Screen Size to make your painting the size of the screen. Or you can select Custom Size, where you can specify any desired page width and height (in pixels). The maximum painting size is twice the area of your screen (for example, in Medium Resolution, 320 x 400, 640 x 200, or any other size up to twice the screen area).

If you are working on a page size larger than the screen, you can scroll to the off-screen portions using the four Arrow keys. You can also preview the entire page at any time by selecting the Show Page option from the Pict menu. Return to your current page by clicking the mouse button.

SCREEN RESOLUTIONS

To change screen resolution, select Screen Format from the Pict menu. The two resolution formats are described as follows:

320 x 200, 16 colors (Medium Resolution): This format uses a pixel array 320 wide by 200 high, and can accommodate 16 colors on the screen at the same time.

640 x 200, 4 colors (High Resolution): This format uses a pixel array of 640 by 200, using pixels that are the same height as the Medium Resolution ones, but only half as wide. High Resolution limits the number of colors available for a single picture to 4.

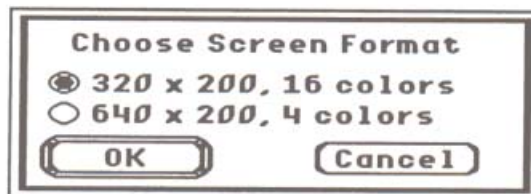

Figure 2.3. Choose Screen Format Dialog Box

You cannot change the resolution of your picture while it is on the screen. Likewise, you cannot load a picture that was saved in a different format.

Note: If you try to load a picture that is in IIGS screen-dump format using either medium resolution or high resolution format, **DeluxePaint** warns you that the picture was saved in another format before loading the picture.

3 THE PALETTE

THE PALETTE AND SCREEN FORMATS

As we noted above, **DeluxePaint** contains a universe of 4096 colors. In the (default) Medium Resolution format, you can use 16 at any given time. High Resolution format allows four colors on the screen at one time. When you first start **DeluxePaint**, the default palette appears below the Toolbox. (To customize this, see the Palette Window below.) When you load a picture, **DeluxePaint** loads the palette you used when you painted the picture and displays it below the Toolbox.

 THE PALETTE WINDOW

To bring up the Palette Window, either Command-click the Color Indicator, press the **p** key, or select Palette from the Color menu. (These methods all produce identical results). The Palette Window (see Figure 2.4) lets you mix your own colors for a custom palette which then appears in the main Palette (below the Toolbox). From a universe of 4096, you can create 16 different colors in Medium Resolution and four colors in High Resolution. The 4096 figure is derived from the fact that any given color can be expressed in terms of its Red, Green, and Blue (RGB) components. With 16 possible shades in each component, the possible universe of colors comes to $16 \times 16 \times 16$, or 4096.

In the Palette Window is the mixing palette, a copy of the main Palette. The current color (the color that you are now working with) is surrounded with a black rectangle called the Color Selector. As you modify the current color, you can watch the color change in the mixing palette.

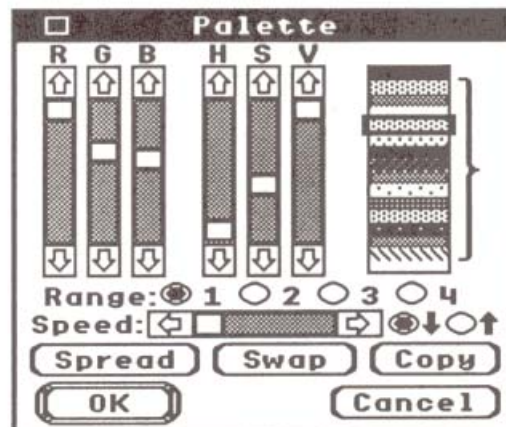

Figure 2.4. Palette Window

The RGB method of color mixing lets you blend Red, Green, and Blue to produce the desired shade. The HSV method provides an alternative approach to color mixing, but with identical results. The HSV method breaks each color down into its Hue, Saturation, and Value. Hue refers to the color's position on the color spectrum or rainbow. As you move the scroll box down the Hue scroll bar (starting from the top), your current color changes to a shade of the following colors — Red, Purple, Blue, Green, Yellow, Orange, and Red. Saturation refers to the strength of a particular hue — whether it is relatively pure (and hence highly saturated), or whether it contains some proportion of white. Thus, the more white, the less saturated. Value refers to a color's black level (and hence the amount of light it would reflect off a surface). A color with a high value would have little or no black, whereas colors with low value would contain more black. Irrespective of Hue and Saturation, a Value of zero produces a pure black.

DeluxePaint lets you mix colors with either method. It also lets you create color spreads to give you subtle shades of the same hue. You can learn about the Palette Window by working through the tutorials in the next chapter (where you will create your own custom palette), or by reading the relevant parts of the Reference section (see Palette in the Color menu). For the time being, just be aware that you can modify the currently selected color on any of the six variables (R, G, B, or H, S, V) by dragging the appropriate scroll box up or down its range. As you do so, note that the two sets of variables are related — for example, after you move the RGB scroll boxes, the HSV scroll boxes respond accordingly. Note that when you modify a color in the Palette Window, all occurrences of that color are also changed on the painting screen *and* the color is immediately changed on the main Palette (below the Toolbox).

The Palette Window also lets you create color spreads to give you subtle shades of the same hue or equally spaced gradations across hues. To create a spread of colors, click the first color, click Spread, and then click the last color. **DeluxePaint** looks at the first and last colors in the spread and at the number of steps in between, and calculates the series of intervening shades. For example, if your first color is a highly saturated red and your last color is a pure white, with ten steps in between, you will end up with a spread of twelve colors ranging from red to white separated by varying shades of pink. Likewise, if your first color is blue and your last color is yellow, **DeluxePaint** calculates the intervening shades and hues, to give you a series of blues, blue-greens, greens, yellow-greens, and yellows. And unlike traditional color mixing, if your modifications are not to your satisfaction, you can always reverse the last change by pressing **u** on the keyboard (for Undo), or you can cancel all the changes you made by clicking the Cancel button in the Palette Window.

Swap and Copy let you swap or copy colors from one part of the Palette to another. If you click a color in the Palette Window, click Swap, and then click a second color, the two colors will change places on the Palette. Similarly, if you click a color, click Copy, and click a second color, the first color will be copied onto the second. By letting you place colors anywhere on the Palette, these two functions make it easier to create the color spreads you need for your work.

The Palette Window's Range function plays an important role in several *DeluxePaint* features, in particular, Color Cycling and Gradient Fill, both of which are treated extensively in the tutorials in Chapter Three. As its name implies, Color Cycling cycles through a defined range of colors to produce simple animation effects. You can define up to four color ranges (one for each of the radio buttons labeled 1 to 4), and you can assign a cycling speed to each one. You define a range using the vertical bracket to the right of the palette in the Palette Window. To set a range, click one of the numbers after Range (for example, 1). Then click one end of the Range bracket and drag it to the first color in the range; drag the lower Range bracket to the last color in the range. See Tutorial One for detailed instructions on creating animation effects using Color Cycling.

DeluxePaint's Gradient Fill function also makes use of the Range information. The currently selected range (a range is selected when one of its members is selected) determines the colors or shades that will be used in a gradient fill. By using a gradient (as opposed to a standard solid) fill with a carefully chosen color spread, you can create shading effects that would make an airbrush artist envious. See Tutorial Two for instructions on gradient fills.

DeluxePaint also uses Range information for some of its painting modes (specifically Blend and Shade), which are available through the Mode Menu. See "Painting Modes" below for information on this feature.

For a list of keyboard equivalents for activities performed in the Palette Window, see the Reference section.

4 THE TOOLS

DeluxePaint's painting tools are available through the Toolbox, the panel on the right-hand side of the screen. As we have already seen, you can activate any tool by clicking its icon with the mouse button. A tool remains active (and its icon highlighted) until you select another tool or, in some cases, until you deselect it by clicking the icon a second time. Examples of the latter kind of tool are the Grid and the Symmetry and Magnify tools, which are toggled on and off by each mouse click.

MODIFYING TOOLS

In most cases, holding down the Command key and clicking the mouse button on a tool icon (Command-clicking) lets you modify some fundamental aspect of that tool. The following summarizes the effects of Command-clicking the tools in the Toolbox:

THE BUILT-IN BRUSHES: You can change the size of any of the built-in brushes at the top of the Toolbox by Command-clicking a brush, moving the cursor over to the painting area, and then dragging diagonally while holding down the mouse button. Release the mouse button when the brush is the desired size. This applies not only to the eight solid brushes, but also to the three- and five-pixel brushes below them.

THE AIRBRUSH: The Airbrush works with any of DeluxePaint's built-in brushes, or with a custom brush of your own creation. You can adjust the Airbrush's nozzle by Command-clicking the Airbrush icon, moving the cursor over to the painting area, and then pressing the mouse button and dragging diagonally to adjust the size of the solid circle, which represents the spray area. Release the mouse button when the solid circle is the desired size.

STRAIGHT LINE AND CURVE TOOLS: A Command-click on either of these tools brings up the Spacing Dialog Box (see Figure 2.5), allowing you to create either straight or curved *dotted* lines. The Spacing Dialog Box lets you control the distance between "splats" in your dotted lines, using either a relative or an absolute measure. If you specify Absolute (by clicking that button), the number in the Number box refers to the number of pixels between the center of each splat. If you specify Relative, then the number refers to the total number of

splats in the line. For example, if you specify Relative spacing with an order of 10, your line (curved or straight) will consist of 10 splats. Note that spacing also works with the Unfilled Shape tools, even though a Command-click on those icons does not bring up the Spacing Dialog Box. To toggle spacing (dotted lines) on and off, click the On box in the Spacing Dialog Box. A check appears in the box when spacing is on.

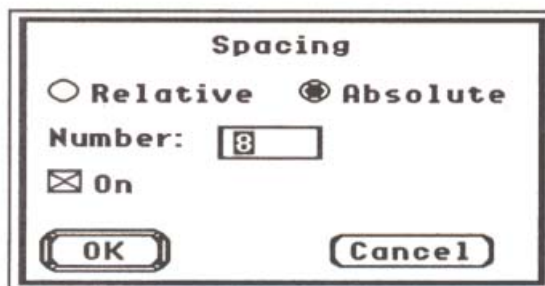

Figure 2.5. Spacing Dialog Box

FILL AND SHAPE TOOLS: Command-clicking the Fill icon or the Filled or Unfilled Rectangle, Circle, Ellipse, or Polygon brings up the Fill Type Dialog Box (see Figure 2.6), allowing you to specify the type of fill to be used by these tools.

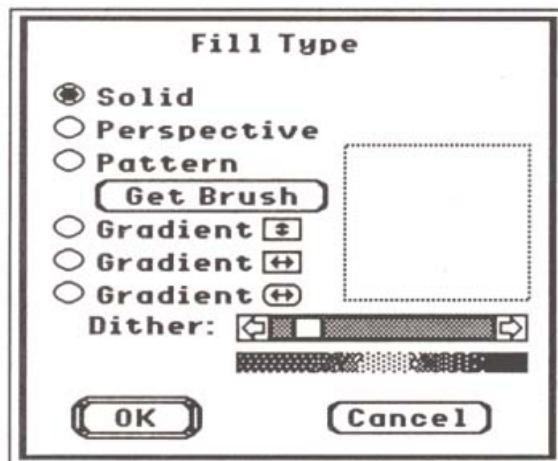

Figure 2.6. Fill Type Dialog Box

The Fill Type Dialog Box is covered in both Tutorials One and Two and in the Reference section; the following is a summary of its features:

Fill Type defaults to Solid, which is a solid-color fill of either the foreground or background color. Clicking the mouse button inside a closed shape fills it with the foreground color, Command-clicking inside a shape fills with the background color. Click Get Brush to create a recurring pattern from your current brush and display it in the Fill Type Dialog Box. Then click Pattern to use that pattern as your current fill.

You can also choose to fill a shape with a gradient made up of a range of colors — for example, if Range 1 contains three colors (black, dark grey, and light grey), the corresponding gradient fill will contain "stripes" of these same three colors. First, select a color in a cycle range (see Tutorial One for details on creating color ranges and using them in gradient fills). To fill a shape with a gradient going from top to bottom, click the top Gradient button (with the arrows pointing up and down); to fill with a gradient moving left to right, click the second Gradient button (with the arrows pointing left and right). Click the bottom Gradient button (with the rounded corners and the arrows pointing left and right) to create a left-to-right gradient fill with a three-dimensional effect. Here, DeluxePaint fills each horizontal line independently, thereby allowing the gradient to fill the contours of the shape being filled. (Note: If your current color is outside all ranges, DeluxePaint will not create a gradient fill but will fill with the solid color.)

The example below shows the results of selecting a range of three colors (black, dark grey, and light grey) and creating three circles, one filled with each type of gradient. (Dither here is turned off.)

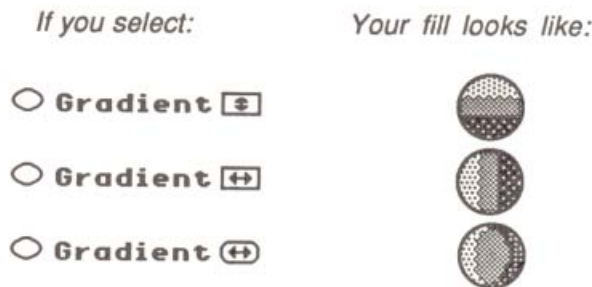

Figure 2.7. Examples of Three Types of Gradient Fill

Whichever kind of gradient fill you choose, you can adjust its *dither*, the amount of random overlap between each shade, by dragging the Dither scroll box left or right. You can look at the current dither setting in the box below the scroll box. When you are done, click OK to use the current settings, or Cancel to return to your work without making any change.

BRUSH SELECTOR: Command-clicking the Brush Selector restores the last custom brush. Thus, if you create a custom brush (see Part 1 of this chapter for details) and then make some modifications, Command-clicking the Brush Selector restores you to the previous custom brush. This feature is also useful if you create a custom brush and then select a built-in brush. Command-clicking the Brush Selector returns you to the custom brush.

GRID AND SYMMETRY TOOLS: Command-clicking these icons lets you modify aspects of gridding and symmetry. See Part 2 of this chapter for a detailed description of these features. To turn off these tools, click the icon again.

5 THE PAINTING MODES

Certain options in the Mode menu — Smear, Shade, Blend and Smooth — let you make subtle modifications to paint that has already been laid down. (The others — Matte, Color, Replace, Cycle, and Multi-Cycle — affect the way paint is laid down in the first place by affecting the current brush. See the Reference section for more information).

Smear and Smooth modify your painting after looking at the colors under the brush (ignoring cycle ranges). Smear is the simplest function — it works just like dragging a brush over a wet oil painting. In other words, Smear works with the colors under the brush, smearing them in the direction you move the brush. Use Smear to create the top of a wave as it's about to break, or foliage on a tree or bush.

Smooth reduces the contrast between two adjoining areas of your painting (for example, a black area and a white area). Smooth looks at the colors under the brush, scans the entire palette for colors that are the "color average" of the colors under the brush (for example, greys), and then lays down these colors. Smooth works best when the

palette contains subtle gradations of the colors under the brush (for instance, various shades of grey) since it has a greater variety of colors to choose from. Use Smooth to smooth out the boundary between two contrasting colors and to obtain effects similar to those obtained with a traditional airbrush or with Antialiasing (one of the Perspective options available through Options on the Brush menu).

Blend and Shade look at the colors under your brush, the current foreground color, and cycle ranges. (See discussion on the Palette, above). With Blend and Shade, you usually work with colors on the screen that are in the same cycle range and you have your current foreground color set to a color within that range. Blend is similar to Smear except that it uses multiple colors from the current color range. If the current foreground color is in the same cycle range as the colors under the brush, Blend smears the colors under the brush (in the direction you move the brush) by adding intermediate colors from the same range. For example, if your range includes Colors 7 to 9, Blend lays down dots of Color 8 as you drag the brush over Colors 7 and 9. If the current foreground color is in a different color range from the colors under the brush, Blend will have no effect on the colors on the page. If the current foreground color does not fall within any color range, DeluxePaint treats the entire palette as a cycle range.

If your current foreground color is in the same range as the color under the brush, Shade paints with the next-higher or next-lower color in the cycle range. (If you press the mouse button, you paint with the next-higher color; if you press the Command key and the mouse button, you paint with the next-lower color.) If the current foreground color is not in a cycle range, Shade treats the entire palette as the range and lays down either the next-higher or next-lower palette color. Use Shade to derive shading effects by adding the next higher (or lower) color in the range to the color on the page.

The painting modes are described in greater detail in the Reference section. See the section covering the Mode menu for more information.

6 TEXT

DeluxePaint's text feature lets you place text anywhere on the page, and the Brush Selector lets you pick it up and reposition it if you didn't have it quite right the first time. You can use any IIGS font with DeluxePaint — provided you have installed it onto your

DeluxePaint program disk. (See your IIGS documentation for instructions on how to move fonts from one disk to another.)

From the Font menu, select the font and style you want (such as the Chicago 12 point font in the Bold style). To enter text on the screen, click the Text icon (A) in the Toolbox. When you move the pointer over to the painting area, it becomes a small vertical line. Click the mouse button where you want the text to begin, and start typing. The text will "wrap" around to the next line when it reaches the end of the line, or you can press Return to start a new line directly below the point where you first placed the cursor. If the page size is larger than the screen, the screen will scroll to the edge of the page as you type. You can delete text on the current line by using the Delete key to backup and erase the previous character you typed. Note, however, that you cannot delete text with the Delete key if 1) the screen scrolls as you are typing or 2) you click the cursor elsewhere on the screen or select a tool from the Toolbox. Then your text becomes a bit-mapped image, and no longer behaves as text.

To exit Text mode, select another drawing tool.

To cut and paste text, click the Brush Selector, and holding down the Command key and the mouse button, pick up the misplaced text. This lifts the text right off the page, letting you reposition it anywhere you want.

In the next chapter you will learn a number of practical techniques, through a series of tutorials, to help you get the most out of **DeluxePaint**. The tutorials are simple, step-by-step exercises, designed with the assistance of professional **DeluxePaint** artists. You won't know how powerful **DeluxePaint** can be until you try it for yourself.

CHAPTER THREE: TUTORIALS

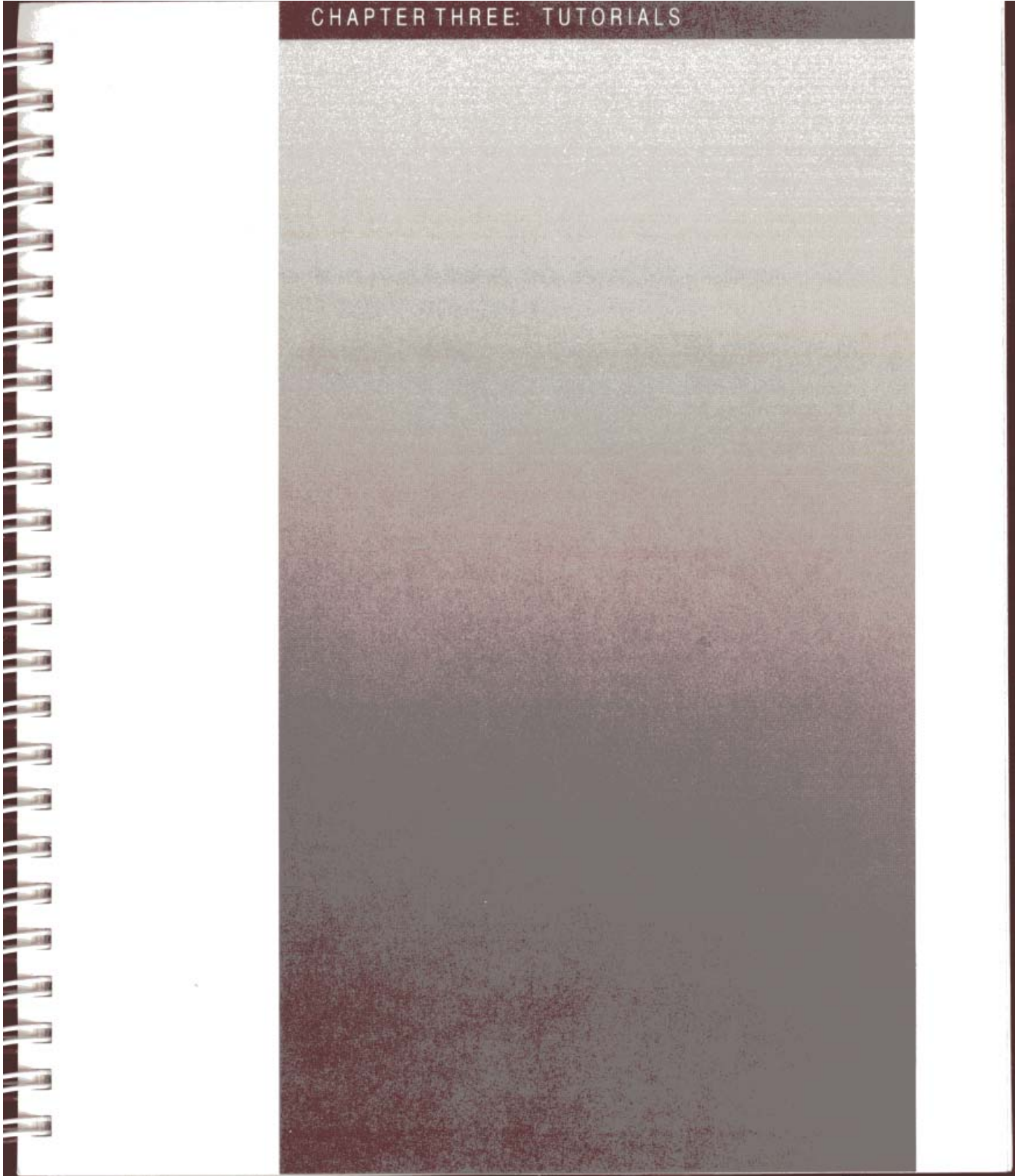

NOTES



CHAPTER THREE: TUTORIALS

The best way to learn DeluxePaint is by doing. Manuals that teach how to drive a car or fly a plane can go only so far — at some point the student has to sit in the driver's seat and work the controls. So far we have just been sitting in the garage, examining all the instruments. Now it's time to start the engine and take the machine out for a spin. As you've probably guessed, this chapter is the "Driver Ed" part of the DeluxePaint manual, the place where you can really start creating impressive graphics.

Tutorial One shows you how to create a custom color palette. Tutorial Two deals with the creation of a business logo, starting with some relatively plain text and finishing with graphics impressive enough to go into an annual report. Tutorial Three takes you through the world of stencils and friskets, and shows you how you can use traditional airbrush techniques with a new medium. Finally, Tutorial Four introduces you to DeluxePaint's perspective capabilities, a way of simulating three-dimensional space on a two-dimensional screen.

Before we begin, let's make sure that you have everything you will need for our journey. First, you'll need your **DeluxePaint** program disk and art disk. The special files and artwork you'll be using in the following tutorials are stored on the program disk in the Brush or Med.Res folders, as appropriate. Second, you'll need a supply of initialized disks for storing your work. Third, if you want to make printouts of your work, you'll need a printer plugged in and ready to go.

1 TUTORIAL ONE: MODIFYING THE COLOR PALETTE

Proficiency in modifying *DeluxePaint*'s color palette is one of the most important skills you can learn. Because every work of art is little more than the colors and shapes that comprise it, a carefully chosen palette is the first step to any masterpiece. In the following exercises, you will learn how to create your own color palette and gradient fill and how to do color cycling. (See the Reference section for a table of keyboard equivalents to use in the Palette Window.)

CREATING YOUR OWN PALETTE

The IIGS can generate 4096 distinguishable colors, 16 of which are available at any one time in Medium Resolution. You can create your own 16-color palette by modifying the colors on the existing palette. Here's how:

- From the Color menu, select Default Palette. (To do this, move the cursor up to the Menu Bar. Hold the mouse button down as you move the cursor down to Default Palette. When you have Default Palette highlighted, release the button.) Then bring up the Palette Window by selecting Palette from the Color menu.

(You can also get to the Palette Window by Command-clicking the Color Indicator (above the main Palette at the bottom right of the screen), or by pressing **p** on the keyboard. As you become more proficient with *DeluxePaint*, you will realize that most of *DeluxePaint*'s features are accessible through the keyboard. You can speed up your work considerably by using the keyboard equivalents. See the Reference section for tables of keyboard equivalents.)

Take a moment to examine the Palette Window (refer to Figure 2.4). It consists of six vertical scroll bars for mixing colors, the mixing palette (where a black-bordered box called the Color Selector marks the currently selected color), and a collection of command boxes. To find out more about these functions, refer to the section on the Palette Window in Chapter Two. For this exercise, you'll be using the Palette Window to create your own custom palette.

- Click on the black in the mixing palette (the topmost color, called Color 1). Note that the R (Red), G (Green), and B (Blue) scroll boxes are all at the bottom.

Set Color 1 to pure red by dragging the R scroll box all the way to the top. (Drag the scroll box by positioning the pointer over it and pressing and holding down the mouse button as you move the mouse. Release the button when the scroll box is just where you want it.) Leave the G and B scroll boxes at the bottom.

Note that as you drag a scroll box up or down its track, the currently selected color in the mixing palette changes color accordingly. In addition, a color change also occurs immediately in the main Palette below the Toolbox. Also note that, since Color 1 is used for drawing all dialog boxes and the Toolbox, when you change Color 1 to red, the Palette Window and Toolbox turn red also.

- Now copy this red onto the next four colors: Click Color 1, click Copy, and then click Color 2. Repeat this for Colors 3, 4, and 5 — creating a total of five red squares.

So far you have created a basic set of reds that you'll be adjusting a little later to make a spectrum. Before you do that, however, let's set up the rest of the palette in the same way:

- Make Colors 6 through 10 green: Slide the R and B scroll boxes all the way to the bottom and the G scroll box to the top.

Make Colors 11 through 15 blue by moving the B scroll box to the top and the R and G scroll boxes to the bottom.

Leave Color 16 as is (white).

Your palette now has five squares each of red, green, and blue, and one white. Next we'll manipulate the saturation levels and color values to create variations within each color. Note that you can also create various shades of a color by creating each color individually, instead of using the Copy function and then making adjustments. As you gain proficiency, you will find that **DeluxePaint** lets you achieve the same results in various ways, giving you the option of choosing the method

best suited to your working style. You can use either method as you work through this exercise.

As we noted in Chapter Two, the RGB and the HSV scroll bars are two different ways of looking at the same thing, and modifying the settings in one group of scroll bars results in modified settings in the other group. As you adjust the HSV settings in the following section, keep an eye on the RGB scroll bars to get an idea of the relationship between the two sets of variables.

As we explained previously, Saturation refers to the amount of white a color contains (the higher the saturation, the less white); Value refers to the amount of black a color contains (the higher the value, the less black).

- Select Color 1, the first red, and move the V (Value) scroll box so that it is two-thirds of the way down the scroll bar. Color 1 will now be a dark red. To check the numerical RGBHSV settings for this color, press **n**. This displays the Color Settings Dialog Box. Your settings should be something like this: Red - 5, Green - 0, Blue - 0, Hue - 0, Saturation - 255, and Value - 91. This numerical information is useful to know if you want to duplicate the same shade on a later palette.

For Color 2, the second red, move the V scroll box so that it is one-third of the way down, and leave the H and S settings as they are. Leave Color 3 (the third red) as is. For Color 4, move the S (Saturation) scroll box halfway down. Finally, for the last red (Color 5), move the S scroll box two-thirds of the way down.

Repeat this same sequence of settings for the greens and blues, then freeze the palette by clicking OK. The Palette Window will disappear from the screen. If you have anything showing on your page, choose Color 16 (white) for your background color, and clear the screen.

Next, just to practice using your new palette, create a color chart on the screen. The finished results should look like this:

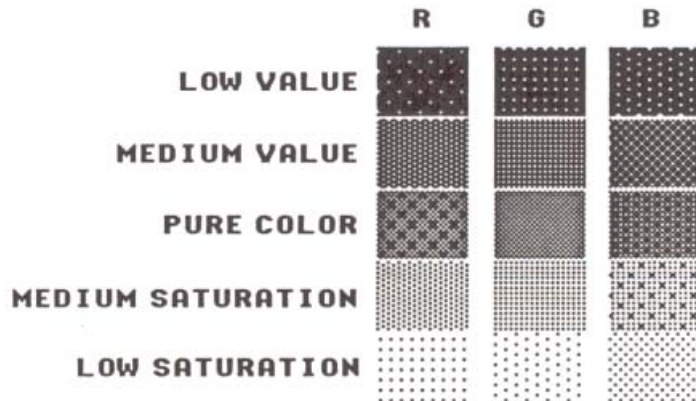

Figure 3.1. Your Color Chart

- Choose Color 1 for your foreground color. Select the Filled Rectangle tool and draw a square about the size of a postage stamp. Click the Brush Selector with the mouse button, and pick up the newly-created square using the Command key and the mouse button. Move your brush about one inch below "e" in the word Mode (in the Menu Bar) and click to place a square there.

Now select Color from the Mode menu to tell *DeluxePaint* that you want to select brush colors from the main Palette (below the Toolbox), and then click Color 2 in the Palette. Note that your brush changes to Color 2 immediately. Place your second square just below the first. Then place squares of the remaining three reds below these two.

Note: To move to the next color in the Palette, you can use the mouse or press the] key (to move down) or the [key (to move up).

You now have a column of reds, ranging from a low-value dark red (almost black) to a low-saturation pale red.

- Now create a column of greens: place a square of Color 6, the darkest green, to the right of the first red square (leave about 1/4 inch of space between the columns). Arrange the remaining greens, from darkest to lightest, in a column under the first green. (Note that the first three greens — Colors 6, 7, and 8 — are at the bottom of the

CHAPTER THREE: TUTORIALS

first column in the Palette. The next two greens — Colors 9 and 10 — are at the top of the second column.) To the right of the green column, create a column of blues using the same technique.

Next, let's label the color chart:

- Select the Text tool by clicking the Text icon (A) to the right of the Brush Selector. Select Color 1 as your foreground color. To start typing text, move the cursor above the first column and click the mouse button. Then use the keyboard to type the column labels (from left to right) as follows:

R G B

If a letter doesn't line up exactly, just lift it up with the Brush Selector (using the Command key and the mouse button) and reposition it.

On the left side of the chart, label the color rows from top to bottom as follows:

LOW VALUE
MEDIUM VALUE
PURE COLOR
MEDIUM SATURATION
LOW SATURATION

If you are using a color printer, you can print out a copy of your palette.

CREATING COLOR SPREADS AND RANGES

As you have probably realized by now, **DeluxePaint** has many advantages over most standard media. Variable magnification, instant "undoing," and the vast power of **DeluxePaint's** brushes have no counterpart in the world of paper, paint, and ink. For example, where once a smooth, gradual fade from one color to another required laborious work with an airbrush, **DeluxePaint's** Gradient Fill does it all in seconds. Some of these more advanced features, however,

require that you set up your color palette in a certain way to achieve maximum effect. This exercise will teach you how to get the most out of the Spread and Range commands to arrange your palette. In addition, you will create a new palette for the following exercise, "Animation with Color Cycling."

First, clear the screen, and then select Default Palette from the Color menu. Select Info Bar from the Edit menu (to give you feedback as you work with colors). Then bring up the Palette Window by Command-clicking the Color Indicator. Now make the following modifications to the palette:

- Click the first color at the top and make sure it is pure black, either by moving the V scroll box to the bottom, or by moving each of the R, G, and B scroll boxes to the bottom. Next, with the first color still selected, click Copy and then click Color 3.

You have just copied Color 1 onto Color 3. This means that both of these are black. Next we'll make Colors 3 through 5 black by using Spread:

- Click Color 3, click Copy, and then click Color 5 to make Color 5 black. With Color 3 selected, click Spread and click Color 5.

You have just turned Colors 3 through 5 black. Note that you cannot change Color 16 (which is currently white) to black. This is to prevent you from losing your Palette Window, since *DeluxePaint* uses Colors 1 and 16 for painting the dialog boxes and the Toolbox.

- Select Color 2 and make it pure white by moving all three R, G, and B scroll boxes to the top. To create a 4-tone spectrum that starts with white at the top (Color 2) and ranges through grey to black (Color 5), click Spread and then click Color 5 (the last black).

Now we'll create a color spread between red and blue.

- Select Color 6 and set it to pure red by moving the R scroll box to the top, and the G and B scroll boxes to the bottom. Next, make Color 11 blue (maximum B, zero R and G).

The pure red and blue colors define the range of hues that will be included in your color spread. Now let's fill in the intermediate colors:

- Click Color 6 (red), click Spread, and then click Color 11 (blue).

The four colors between pure red and pure blue are now a range of magentas and violets.

Now you have a spread of colors for your palette, as well as a selection of greys. Next we'll see how to get more subtle tints and shadings of one color (blue):

- Set Color 12 to pure black. At Color 14, create pure blue (B scroll box all the way to the top, R and G all the way to the bottom). Select Color 12 (black), click Spread, and then select Color 14 (blue). Finally, make sure Color 16 is white and create a spread from Color 14 to Color 16 to give you a set of blues varying in saturation and value.

You can use this same technique to create tonal ranges for different colors. Try creating sample tonal ranges for reds and greens.

We've just seen how to set up our color palette using the Spread command. However, to use Gradient Fill and Color Cycling (as well as Shade and Blend, see *The Painting Modes*, in Chapter Two), you have to define *color ranges*, to let **DeluxePaint** know which set of colors to use. You can define up to four ranges within a palette. Here's how:

- After the word Range, click the radio button labeled 1 to define the first color range.

Note that there is a Range bracket to the right of the mixing palette. This tells you which colors are within that range.

- Point to the top of the Range bracket and drag it to the top of Color 2 (white) by holding down the mouse button as you move the pointer. In the same way, drag the bottom of the Range bracket to the bottom of Color 5 (black). The bracket now identifies your newly-defined color range.

Now click the Range 2 button, move the bottom end of the bracket to Color 11 (pure blue) and the top end of the bracket to Color 6 (pure red). Click the Range 3 button and move the ends of the bracket to Color 16 and Color 12.

You have now defined three color ranges:

- 1: Four shades from Color 2 to Color 5 (greys)
- 2: Six shades from Color 6 to Color 11 (red-to-blue spread)
- 3: Five shades from Color 12 to Color 16 (blues)

As you click the Range 1, 2, or 3 button, the bracket identifies the colors in that range.

Now that you've defined a set of ranges, let's try an experiment with DeluxePaint's Gradient Fill feature. Gradient Fill lets you fill any outline with a range of colors that gradually fade from one to the next (see Figure 2.7). Here's how:

- Click OK to leave the Palette Window. Select any color in the first range (Colors 2 through 5) as your foreground color. Now bring up the Fill Type Dialog Box (refer to Figure 2.6) by Command-clicking the Fill tool. To get Vertical Fill, click the first Gradient radio button (the one followed by the box with the vertical arrows). Then move the Dither scroll box all the way to the left, and click OK to return to the painting area. (Dither is the amount of mixing that occurs between the colors in the range.) Now click the Filled Rectangle tool (click the bottom right part of the icon).

Note that as soon as you click a color in one of your three ranges, the small rectangle in the Info Bar gives you a preview of the gradient fill. (If the Info Bar is not displayed, press 9 on the main keyboard.) Try clicking colors within the different ranges and watch it change. As soon as you are ready to move on, click one of the colors in the first range.

- First, set the screen background color to light blue (for contrast) by Command-clicking Color 15 and then clicking CLR. Draw a filled rectangle using the mouse button. Note that the shape gradually fills with a banded, metallic shading effect. Bring up the Fill Type Dialog Box again and drag the Dither scroll box about a quarter of the way to the right. Click OK and then draw a second rectangle. This time you'll see increased dithering: the shades of grey blend from one to the other, without clear lines between them.

Now that you have the basics down, try experimenting with different settings. Bring up the Fill Type Dialog Box again and set it to Horizontal Fill by clicking the middle of the three Gradient buttons.

Draw a filled circle with this kind of gradient fill. Now try Horizontal Line Fill (the bottom Gradient button), and draw another filled circle. Horizontal Line Fill calculates the distance between the left and right borders of a figure and fills each horizontal line independently, so that each line receives the full complement of the gradient fill. (Note that this circle appears more three-dimensional than the previous one.)

Select Color 6 (in range 2) and try drawing diamond shapes with the Filled Polygon tool using both types of horizontal fill, and see the difference.

Select Color 12 (in Range 3) and draw a filled ellipse. Display the Palette Window and reverse the order of the gradient fill by clicking the other cycling direction arrow to the right of the Speed scroll bar (refer to Figure 2.4). Now create another filled ellipse.

(Note: To cancel the Gradient Fill feature, display the Fill Type Dialog Box and click the Solid button. Your filled shapes will now be a solid color — the current foreground color you've selected on your Palette.)

ANIMATION WITH COLOR CYCLING

Most animation effects are created by displaying a series of drawings in rapid sequence. *DeluxePaint*'s animation with color cycling uses a slightly different technique: the illusion of motion is created not by changing images, but by rapidly changing the colors within a static image.

Clear the screen. Using Load Picture in the File menu, load the file **Animations** (in the Med.Res folder).

- Press **9** to hide the Info Bar and **0** to hide the Menu Bar and Toolbox/Palette. (You can bring them back later by pressing the same keys a second time). Activate color cycling by selecting Cycle from the Color menu, or by pressing the Tab key. Pressing Tab a second time stops the animation. Here's how each animation works:

1. **THE COLOR WHEEL:** The wheel was drawn with lines radiating out from the center. Each line's color is one shade away from the lines next to it. As the colors cycle, the wheel appears to spin.

2. **FALLING SNOW:** This was done in the same way as 3 below.

3. **THE BOUNCING BALL:** Each position of the ball was drawn in a different color from Range 2. Because five of the six colors in this range are black, only one frame shows at a time, as the remaining five are invisible against the black background. Change the black colors in this range to any non-black color to see all the frames.

4. **MARQUEE:** This effect was created with the 2 colors from Range 4. In fact, the "lightbulbs" are only flashing on and off. The viewer imagines the motion, just as he does with a real movie marquee. (Change Color 16 from black to another color to see all the frames.)

5. **THE RUNNING MAN:** This was done in exactly the same way as the Bouncing Ball. Notice how the frames overlap slightly.

Bring up the Palette Window, and play with the animation speed of the Color Wheel by clicking the Range 3 button, and then moving the Speed scroll box. (To the left is slower, and to the right is faster. If the scroll box is all the way to the left, cycling is turned off.) You can change the direction of the cycling by clicking the other arrow to the right of the Speed scroll bar.

2 TUTORIAL TWO: LOGOS UNLIMITED

In this series of tutorials, we will take a relatively plain corporate logo and spice it up with some of **DeluxePaint**'s tools. We have provided the original logo for you so you won't need to start from scratch. All you need to do is embellish it by following the step-by-step instructions. First, however, you will need to load the original logo, which has been saved as a brush in the Brush folder of your **DeluxePaint** art disk. From the File menu, select Load Brush; select the folder Brush, and click Open. Then select the file **Archbrush**, and click Open again. When the brush has finished loading, select Use Brush Palette from the Color menu to use the same palette the brush was created with. Finally, Command-click Color 1 (black) and then CLR to change the background color to black.

Let's see how easy it is to spice up the standard logo:

ITALICIZE

Let's begin by italicizing the logo. **DeluxePaint** lets you tilt any image, whether text or graphics, just by making a menu selection. Here's how:

- From the Brush menu, select Shear. Move the brush onto the screen, and, while holding the mouse button down, move the mouse horizontally across the screen. When you are satisfied with the slope of the letters, release the button.

As you can see, Shear anchors the top part of any image, thereby allowing you to stretch the bottom part horizontally in either direction. If you are doing this with text (as we did above), you can italicize letters to any angle you wish. Click the mouse button to place a copy of this new brush on the screen. If you want to save the new brush (remember, it's a brush, not just an image on the screen), select Save Brush from the File menu, specify the folder and filename (make sure you don't give it the same name as the original), and then click Save. To save onto your second drive, first click Disk.

BEND

This time, we'll bend the logo vertically. Although you are free to compound these effects (that is, you can bend an image that has already been italicized), let's start with the original brush again so we can see what effect bending has by itself. To restore the original brush, Command-click the Brush Selector icon in the Toolbox. This restores the brush to its immediately preceding state. (If you modify a brush more than once, you cannot restore it to its *original* state using this technique — you would need to load the brush again.) Now bend the brush as follows:

- From the Brush menu, select Bend Vertical. Move the brush to the center of the screen and, while holding the mouse button down, drag up or down to "bend" the brush. When you release the button, you will see that the brush now has a new shape. Click the mouse button to place an image of the new brush on the screen.

If you like, you can save the new brush on disk. Just follow the instructions outlined in the Italicize section above.

RESIZE

In this exercise we'll resize the brush, stretching or shrinking it to a different size. Restore (or reload) the original brush and then follow these steps:

- From the Brush menu, select Stretch. As you move the brush back onto the screen, you will notice that your cursor has changed to a box with a smaller box inside. While holding down the mouse button, drag the mouse diagonally. Drag it down and to the right to stretch it, and up and to the left shrink it. When you are satisfied with the new size, release the button.

Note that if you want to resize the brush in proportion to the original — that is, keeping the original ratio of height to width — press the Shift key before you start dragging the mouse, and hold it down as you drag. By constraining the change in this way, you can resize the image in direct proportion to the original. Also note that if you try to make a brush larger than the available memory can handle, the brush will snap back to its starting size and shape.

CHANGING COLORS

In this exercise, we will change the colors of the original brush — red and grey on a black background — to a new set of colors. After reloading the brush, click with the mouse button to place an image of the brush on the page. Here's how to change the brush's colors:

- ☛ Click a medium blue shade from the Palette. This is your new foreground color, soon to be the new brush color.

Next, select the red of the original brush as the background color. You can do this using either of two techniques. First, you can select the red by Command-clicking the mouse button on that color in the Palette. (Make sure you select the correct red.) Alternatively, you can click inside the Color Indicator (your cursor changes into the Color Selector cursor). Now when you Command-click on a screen color (for example, red), that color will become the new background color.

Because it can convert your entire painting area into a palette, this technique of clicking the Color Indicator to select any screen color as the new foreground or background color is particularly useful. Whatever color you click in the painting area with the Color Selector cursor becomes the foreground color, and whatever color you Command-click becomes the background color. (You may find the keyboard equivalent even more useful: press the comma key to get the Color Selector cursor, and then click on any of the screen colors as described above.)

Make sure that your new foreground color is medium blue and the background color is red. The next step is to switch the foreground and background colors, so that every pixel of the current background color (red) in the brush will change to the current foreground color (blue):

- ☛ From the Color menu, select Back -> Fore Brush.

Notice that selecting Back -> Fore Brush changed the red parts of the brush to blue. If you had an original brush that contained both red and blue, you could make the changes work in both directions by selecting Back <-> Fore Brush and then changing the background color to something other than red (to make the red visible instead of transparent). This would change all the red parts of the brush to blue, and all the blue parts of the brush to red.

Now that you've seen how easy it is to change colors, you might want to try changing colors on all the brushes you'll be creating in this tutorial.

PATTERN FILL

Reload the original brush by selecting Load Brush from the File menu. When the brush has loaded, place an image of it on the screen by clicking with the mouse button.

In this exercise, you'll be coloring the brush image with a pattern rather than a solid color. Here's how:

- Load **Pattern1** from the Brush folder and select Use Brush Palette in the Color menu. Your new brush will be a small square with horizontal blue stripes. Now Command-click the Fill tool icon to bring up the Fill Type Dialog Box. Click Get Brush. This last action places a copy of the current brush pattern (the one we just loaded) in the dialog box. Click Pattern to set this pattern as the current fill; then click OK.

The next step is to use this pattern fill to spice up our logo:

- Click the Fill tool icon, place the dripping paint portion of the cursor on the grey parts of the arch graphic, and click until the arch is completely filled with the pattern (two applications should do it).

You might want to do the same thing with the lettering, but this time try creating your own pattern. Using the Straight Line tool and the second round brush from the left, draw a series of horizontal deep-blue lines, equally spaced from each other (about one pixel apart should work fine). Now click the Brush Selector and pick up some of the brush, one that will give you a recurring pattern. Command-click the Fill tool icon to bring up the Fill Type Dialog Box, and select Get Brush as before. If the pattern in the box does not look right (e.g., if it has an extra white line somewhere), go back to the pattern on the screen and pick it up again, this time making sure you don't pick up too much or too little. When you are satisfied, go back to the Fill Type Dialog Box and click Get Brush and Pattern and then OK to complete the transaction. Now when you use the Fill tool icon, the paintcan will be filled with the pattern you created. As you click on each letter of the name, it will fill with the new pattern.

DROP SHADOWS

In this exercise we will give our logo a professional touch by adding a *drop shadow*. A drop shadow creates an illusion of depth by putting a dark shadow under an object. First, load your standard Archbrush, and then click the color you want to use for the shadow (making it the foreground color). Black and brown are the most appropriate shadow colors. Then do the following:

- ☛ Select Color from the Mode menu (or press the 2 key, the keyboard equivalent).

The Color option turns a multicolored brush into a solid color, the currently selected foreground color. This is a way of selecting brush color from the Palette, just as we did when we created your custom palette in Tutorial One. When you are in Color mode, **DeluxePaint** uses just the outline of the brush, and colors it the current foreground color.

- ☛ Position the new (solid-colored) brush on the screen and click to place an image of it there.

You have just placed a copy of the logo's shadow on the screen. Now you need to revert to the standard brush so you can place a copy of the logo over the shadow.

- ☛ Select Matte from the Mode menu to restore the brush to its original form (or press 1) and position it over the shadow. Offset the standard brush slightly so you can see the shadow underneath it and press the mouse button.

You have just created a logo with a drop shadow to create the illusion of the logo hovering slightly above the page. You might want to save it as part of your library of Arch logos. Remember to give it a different name before you save it; otherwise you will lose the original brush.

OUTLINING THE LOGO

In this exercise, we will put a different-colored outline around the logo. As before, begin by reloading the standard Archbrush and then select as your foreground color the color you want to use for the outline. Choose a color that is not already represented in the logo, as this will make it easier to change it later without affecting the rest of the logo.

- ☛ Select Color from the Mode menu (or press 2).

As before, this turns your multicolored brush into a solid color, the one you chose as your foreground color.

- ☛ Select either the Unfilled Rectangle tool (for a squared-off outline) or the Unfilled Circle (for a rounded outline). Move the crosshair back to the screen and, holding the mouse button down, drag down diagonally a few pixels. Each pixel you drag the mouse increases the thickness of the outline by that amount. Release the button.

As you have probably noted, the Rectangle and Circle drawing tools paint with the current brush, whether it is a built-in or a custom brush. This lets you create an accurate outline of any shape, just by dragging it the required distance.

- ☛ To revert to the original multicolored brush, select Matte from the Mode menu (or press 1), or Command-click the Brush Selector. Position the original brush over the outline and click the mouse button to deposit an image there. You can now pick up your new logo as a brush, and then repeat the same procedure to produce multiple outlines.

GRADIENT FILL

One of DeluxePaint's most powerful features is its ability to fill a shape with multicolored gradients as well as with solid colors. In this exercise, we'll see how easy it is to create a gradient pattern and fill the arch in our logo with it. As before, clear the screen, restore or reload the standard Archbrush, and place a copy of it on the screen by clicking the mouse button. First we'll define our gradient range:

- ☛ Bring up the Palette Window by Command-clicking on the Color Indicator, or by pressing p from the keyboard. From the Palette Window, create the color range you wish to use for your gradient fill. (For creating a color range, see Tutorial One). When you've defined your ranges, click OK to return to the painting screen.

We have now created a color range to use as a gradient fill. Now when you fill a shape with a gradient fill, it will use that color range. First, however, you need to select one of the colors in the range by clicking it with the mouse button. Next, you need to tell **DeluxePaint** to use that color range as a fill pattern. Here's how:

- ☛ Command-click the Fill tool icon.

This tells **DeluxePaint** that you want to customize the icon's effect, and brings up the Fill Type Dialog Box. Remember, Command-clicking the drawing tools lets you customize the respective effects; see *The Tools*, in Chapter Two, above. Now you need to select the variables you want to use for your gradient fill:

- ☛ Click the top Gradient radio button (for Vertical Fill), and then drag the Dither scroll box left or right to create the desired amount of dithering in the gradient. Click OK to complete the transaction. When you return to the painting area, click the Fill tool with the mouse button to select it, and then click on the arch symbol to fill it with the gradient.

Try experimenting with different gradients and dithering to get an idea of the variety of effects available to you. Try the different gradient fills and see how they work on the Arch logo.

You have just seen how to take a relatively plain logo and embellish it with some of **DeluxePaint**'s tools. In the next tutorial, we will explore the uses of stencils and friskets.

3 TUTORIAL THREE: THE WORLD OF STENCILS

In the following set of exercises, you will learn how to create and use stencils within **DeluxePaint**. Although stencils are primarily used for producing quick, uniform lettering by amateur signwriters, they have uses that go far beyond that. Airbrush artists, for example, use stencils (called *friskets*) to cover certain areas of their work while they airbrush other areas. In fact, for an airbrush artist the creation of friskets is probably the single most important part of a job, because the final image can be only as good as the friskets that define the boundaries between its various areas.

DeluxePaint makes it easy to create a stencil for any part of an image, without the need to redraw the image. All you need to do is specify the colors that make up the stencil, and **DeluxePaint** does the rest, even if the image is highly intricate. By contrast, an airbrush artist has to create his image twice — once when he draws the original design, and again when he cuts out the friskets.

Here's how it works: when you make a stencil for a particular set of colors, you are locking (and thus protecting) any parts of the picture that are made up of those colors, making them impervious to any overspray. This means that when you have a stencil for a particular set of colors, you cannot paint over those colors until you turn the stencil off. It also means that you can essentially paint a picture backwards, from the foreground to the background, because you can use stencils to mask any foreground objects from the colors you are using for the background objects.

The following exercises explore various aspects of stencils in **DeluxePaint**. Before you begin, go to the File menu and load the picture called **Stencilset** from the Med.Res folder on the **DeluxePaint** art disk.

DISTANT SNOWCAPS

The left part of the Stencilset picture shows a distant mountain range behind a green field and under a colorful sky. (If you followed the preceding tutorial, you'll realize that both the sky and the field were created with a Gradient Fill, in a fraction of the time it would take using more traditional techniques. See the Gradient Fill exercise above.) Note that the mountain range is actually made up of several ranges, with the more distant ones painted in lighter shades than the nearer ones. In this exercise, we will put a snowcap on the most distant range without disturbing any other parts of the picture. This would be a tall order for any other graphic medium, but is surprisingly easy with **DeluxePaint**. For example, if you were to do this using a standard airbrush, you would need to cut out friskets to cover every part of the image *except* the distant mountain range, and then spray the picture, all the while hoping that none of the snow color would bleed under the friskets.

Let's create a stencil that "locks" every color in the picture except Color 4, the color of the most distant mountain range. We cannot paint over locked colors. So, in this case, Color 4 will be the only color we can paint snow on.

- From the Pict menu, select Make Stencil to bring up the Make Stencil Dialog Box (see Figure 3.2). Click Clear, click on Color 4 (the blue of the most distant mountain range), click Invert, and then click Make.

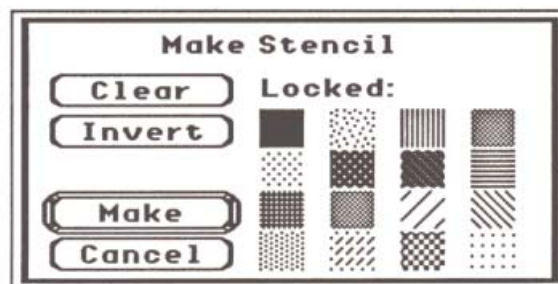

Figure 3.2. Make Stencil Dialog Box

The first click cleared the picture of any stencils, the second selected the stencil color, the third click inverted the stencil configuration (making everything except Color 4 a stencil), and the fourth made the

stencil. To let you know that you have a stencil active, an "S" appears on the Info Bar. (If the Info Bar is not showing, select Info Bar from the Edit menu.)

Note that clicking Invert simply inverts the current stencil configuration, saving you the trouble of clicking all the colors except the one you want to paint on. This is useful if you want to paint on one or two selected colors to the exclusion of the rest; if you want to create a stencil to lock only one or a few colors, then use the direct approach. The next step is to paint the snow on the distant mountain range:

- ☛ Select white as the foreground color by clicking Color 16, and then select the one-pixel brush and the Airbrush tool. Move the cursor over to the distant mountain range and spray a snowcap on it.

Because every color except that of the mountain range has been locked, you can spray without fear of contaminating any adjoining colors. Note that although the white you are spraying on the mountain range is one of the locked colors, it is not itself locked while you are applying it. This means that you can paint over it with another color (such as the original color of the mountain, if you don't like the look of the snowcap) just as though it were unlocked. To lock a recently applied color, select Make Stencil again and click the Make button.

This also means that you can use the "Again" key (a) to bring back the Make Stencil Dialog Box, if Make Stencil was your last menu command. (The Again rule is simple: press a whenever you want to repeat the immediately preceding menu command, to save your moving the mouse up to the Menu Bar and through menu options. If your last menu command produced a dialog box, then pressing a will produce that same dialog box, without the need for menu selections.)

SUNRISE IN THE ROCKIES

In this exercise, we will make the sun rise *behind* the mountains in the Stencilset picture. So we need to lock every color except the sky. Here's how:

- ☛ Bring up the Make Stencil Dialog Box, click Color 4 (the distant mountain color) to lock it, and then click Colors 2 and 6 through 9 (the sky colors) to unlock them. Click Make.

You have now locked every color in the landscape except the sky colors. Now let's make the sun rise:

- ☛ Make black your current background color. Click the Brush Selector, move the large crosshair over to the sun image (on the far right of the screen), and pick it up with the mouse button. Move the brush over to the sky above the mountain range. (Note: You won't see the brush until you move it to the sky area.)

Did you see the sun move *behind* the mountains and then peek through? This is because every color — except the sky colors and the background— is locked, and so will not accommodate the sun brush. When you are satisfied with the placement of the sun, click the mouse button to stamp an image of it there.

CUTTING SOME Z'S

In this exercise, we will explore further aspects of *DeluxePaint*'s powerful stencil editor. In particular, you will see how to turn stencil colors on and off from your screen, not just from the Make Stencil Dialog Box. (In this exercise, we are still working with the *Stencilset* picture.)

- ☛ Bring up the Make Stencil Dialog Box, and click Clear to clear all the stencils. Select a color other than red, blue, or yellow as your background color — for example, Color 11, green. (Thus, when you pick up your brush below, none of its colors will be transparent.) Now move the pointer outside the dialog box and click the large Z shape at the bottom of your picture. Click Invert in the dialog box and then click Make to create a stencil and return to the painting screen.

Now let's see what we can do with the stencil we just created:

- ☛ Click the Brush Selector and pick up the textured area to the right of the Z. Move the cursor over to the Z and watch what happens.

Did you see the textured brush appear behind the Z? Because all the colors except the Z are locked, it looks like you are viewing the textured brush through a Z-shaped window. Now, when you place the textured brush behind the Z and click the mouse button, you will fill the Z with the textured pattern.

THE EYES HAVE IT

You may have trouble finding a practical application for this next exercise, but it's fun nonetheless.

- Open the Make Stencil Dialog Box, click Clear, and then click the following colors: 3, 6, 15, and 10. Click Make to complete the transaction. Now pick up the two blue circles at the lower right and move them over to the face.

Because all the colors in the face are now locked, the two circles appear to move behind it. When the circles are directly behind the eyes, you can make the eyes appear to move around just by moving the cursor around. You can set the eyes in any position you like just by clicking the mouse button. If you don't like it, click Undo and try again.

FIXING THE BACKGROUND

By using a combination of stencils and fixing the background, you can define a stencil by area rather than color. This lets you confine a stencil to a particular area of the page, without forcing you to lock every instance of a particular color. Let's take a closer look:

- Cancel the previous stencil by selecting Free Stencil from the Pict menu (or by pressing the `⌘` key to the left of the Spacebar). Make sure your current background color is black.

Pick up the small clump of pine trees from the right-hand side of the page (above the blue circles). From the Pict menu, select Fix Background.

You have just fixed the picture to the background (the B in the Info Bar tells you so), which means you can always return to that picture by clicking CLR. Thus, you can stamp pine trees all over the landscape and then return to the original picture at any time. You can also fix the background successively, updating the picture from the previous "fix." (As we saw earlier, you can press `a`, the Again key, to repeat the immediately preceding menu option.) For the purpose of this exercise,

go ahead and stamp a few clumps of pine trees on the closest mountain range. Now let's turn that collection of pine trees into a stencil:

☛ From the Pict menu, select Lock Foreground.

This last action turned the foreground (i.e., everything you added to the picture since fixing the background) into a stencil, but without affecting any other part of the picture that uses those same colors. Try it and see. Move your pine-tree brush over to the pine forest and you'll see that your brush goes behind the forest but in front of everything else. You can remove this stencil either by turning the stencil off (selecting Toggle Stencil from the Pict menu) or making a different stencil by locking colors in the Make Stencil Dialog Box. And as is the case with regular stencils, clicking CLR does not clear the stenciled area — it is protected until you turn it off, just like the fixed background.



4 TUTORIAL FOUR: PUTTING THINGS IN PERSPECTIVE

In this tutorial, we will be examining the rotation and manipulation of brushes about the three spatial axes to produce perspective effects without the need for technical drafting tools.

In Perspective mode, you work within the three spatial axes — x , y , and z — to create three-dimensional objects. Visualize that the x and y axes are on the surface of your screen and the z axis runs perpendicular to the screen (toward the back of your monitor), as illustrated in Figure 3.3 below.

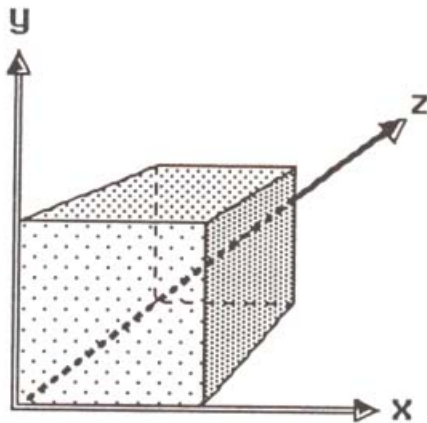

Figure 3.3. The Three Axes Used in Perspective Mode

In this manual, the three axes always refer to the orientation of the brush. When you first enter Perspective mode, the screen's x -, y -, and z -axes correspond to the brush's x -, y -, and z -axes. Once you rotate the brush, however, the brush and the screen no longer share the same axes. In Figure 3.4 below, a brush is rotated away from you about its x -axis. The x -axis remains the same, but both the y - and z -axis have been rotated. Figure 3.4 also shows the brush's original y -axis and its new y -axis.

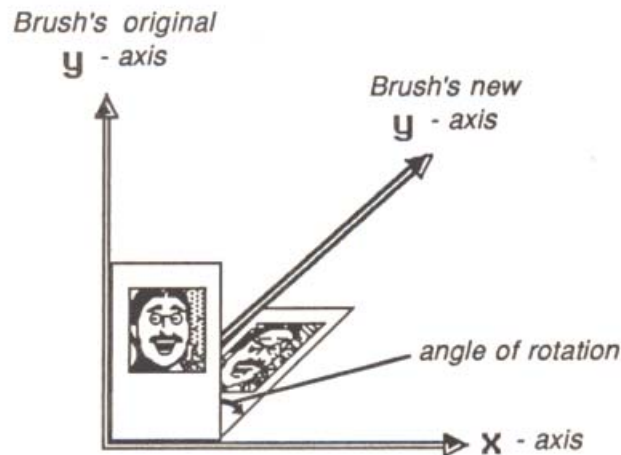

Figure 3.4. Example of a Rotated Brush

Perspective mode also lets you place the perspective center (the point level with the viewer's eye) anywhere on the page. In addition, by selectively fixing any one of the three axes, you can make your brush change size as it moves up and down the page, letting you create objects that recede into the distance. Here are some exercises showing you how:

AN AREA RUG

In this exercise, we will learn how to rotate the image of an object (an area rug) to change its perspective.

- ☛ From the File menu, select Load Brush, and open the Brush folder. (You might have to close another folder first.) Then load the brush named **Dolphin**. Select Use Brush Palette from the Color menu. Set the background color to white, and click CLR. Select Info Bar from the Edit menu. Make sure that Coordinates and Brush Handle (in the Edit menu) are turned off.

Our first job is to define the perspective center (the viewer's eye level). For the purposes of this discussion, let's assume that there is a horizontal plane (the *view plane*) passing through that point.

- From the Brush menu, select Perspective or press **Enter** on the keypad.

Note that when you do so, your brush turns into a large four-cell rectangle (called the brush outline). This is how your brush is represented in Perspective mode. You will also notice a small crosshair in the center of the page. This is the existing (default) perspective center.

First, let's change the perspective center:

- Press the **Decimal Point** on the keypad. This changes your cursor into a large crosshair. Move the large crosshair to a point about one inch below the Menu Bar and about halfway across the page, and click the mouse button.

This sets a new perspective center until we change it again. The cursor now changes back into the four-cell brush outline.

As we noted earlier, you can rotate your brush about any of its three axes, x, y, and z. When you first enter Perspective mode, your brush and the screen share the same axes; that is, the brush's y-axis corresponds to the screen's y-axis, and so on. Thus, moving the mouse backward and forward causes the brush to move *up and down* on the screen, along its y-axis. (And moving the mouse left and right causes the brush to move left and right, along its x-axis). When you rotate the brush (and its axes), mouse movement still translates into movement along the x- and y-axes, but these axes are now relative to the brush's orientation, rather than to the screen. For example, suppose you rotate a brush so that its y-axis is now running perpendicular to the screen. When you move the mouse backward and forward again (to move the brush along its y-axis), the brush outline will now move *closer to you and farther away*.

If you would like to read more about **DeluxePaint's** perspective features, see the discussion under the Brush menu in the Reference section. However, it's a lot easier to understand how perspective works by trying a few examples. To illustrate an important rule of perspective, we will paint a "rug" on the floor using two different methods.

Method 1: With this method, we'll rotate the brush first, and then fine-tune its plane relative to the view plane by using the apostrophe key. First let's rotate the brush:

- Move the brush outline so that its center coincides with the perspective center. Hold down the Shift key and press **Keypad 8**. (Or to watch the brush outline rotate one degree at a time, hold down **Keypad 8** until 90 appears at the right of the Info Bar.)

You have just rotated the brush 90 degrees about its x-axis. But because the center of the brush corresponds to the perspective center, you are viewing the brush edge on, which explains why it is difficult to see. Note that the brush's y-axis is now perpendicular to the screen and its z-axis is now vertical, which means the rug is lying flat. You can always tell the current state of rotation in degrees (relative to the screen) from the coordinates at the right of the Info Bar. At the moment, it shows 90, 0, 0 to indicate that the brush has been rotated 90 degrees on the x-axis, with zero rotation for the y- and z-axes.

(A note about the Shift key: When used in conjunction with the other keys that affect brush orientation, the Shift key increases the increments of rotation or movement along an axis. For example, by using the Shift key when you pressed the **Keypad 8** above, you were able to rotate the brush 90 degrees with a single movement. You could have achieved the same result by pressing the un-Shifted **8**, but you would have had to do so 90 times (since each keypress rotates the brush one degree). Note that 90 degrees is the default rotation value (called the Angle Step) that is linked to the Shift key. You can enter a new value by Command-clicking the Grid icon while in Perspective mode.)

Now let's define a new brush plane. Since we want to paint a rug on the floor, we'll move the brush down its z-axis (the screen's y-axis), so that the brush is below eye level:

- Hold down the Shift key and press the ' (apostrophe) key.

You have just shifted the brush down its z-axis, so that it is below eye level. The apostrophe and the semicolon keys control movement down and up the brush's z-axis, letting you fine-tune the brush plane after rotation. Now as you move the mouse forward and backward, the brush outline moves forward and backward, along the plane we defined.

Let's paint the rug on the floor:

- ☛ Move the brush outline so that its base is near the bottom of the screen, and click the mouse button.

The result is a view of a rug as it might appear from normal eye level.

Method 2: Now let's create the same effect using a more direct method. In Method 1 above, we rotated the brush at a time when the brush center coincided with the perspective center. Because the brush plane and the view plane were identical, we had to take a further step to adjust the brush plane, by using the apostrophe key. In Method 2, we'll move the brush center *below* the perspective center and define a new brush plane first; then we'll rotate the brush.

First let's define the brush plane:

- ☛ Click CLR to get a fresh page. Press Keypad 0 to reset all three axes to zero. Position the brush outline so that its center is about one third of the way down the page.

Now let's rotate the brush:

- ☛ Press Shift Keypad 8 (to rotate the brush 90 degrees around its x-axis). Click the mouse button to paint the brush in its rotated form.

By positioning the brush outline below the perspective center, we set its x,y plane parallel to but below the view plane, and we did so without using the apostrophe key. This illustrates the first important rule of perspective:

The location of the brush outline at the time you rotate the brush determines the position of the brush plane relative to the view plane.

Whichever method you use, the result is a rug as it might appear from normal eye level. You can "clean up" the image by selecting Options from the Brush menu and then Anti-Aliasing Low or High from the Perspective Options Dialog Box *before* you place an image of the brush on the page. Note that with anti-aliasing turned on, it can take substantially longer to paint a rotated brush.

A RUG ON THE CEILING

In this exercise, we'll rotate the brush to provide us with a view of the same rug as it would appear if it were mounted on the ceiling. This time we need to use the opposite procedure:

- ☛ Click CLR to get a fresh page. Press **Keypad 0** to set all axes to zero. Press the **Decimal Point** key on the keypad and move the large crosshair to the center of the page and about one inch from the bottom, and click the mouse button. Move the brush outline so that its center is about two-thirds of the way up the page, and press **Shift Keypad 7** to rotate the top of the brush 90 degrees towards you (or hold down **Keypad 7** until 270 appears in the Info Bar.) Click the mouse button to paint the area rug on the ceiling.

We have already seen that **Keypad 8** (and **Shift Keypad 8**) control rotation about the brush's x-axis. The same applies to **Keypad 7**, except that it rotates the brush in the opposite direction about its x-axis. **Keypad 9** resets the x-axis to zero rotation. This means that all x-axis rotation is controlled by the *top* row of keys on the keypad.

In like fashion, all y-axis rotation is controlled by the middle row of keys on the keypad, and z-axis rotation by the bottom row. Thus, to rotate the brush about the y-axis, press the **Keypad 4** or **5** keys, and to reset the y-axis to zero, press the **Keypad 6** key. To reset all three axes to zero, press **Keypad 0**. By now, you have the fundamentals of perspective at your fingertips, so you should feel free to experiment with different brush rotations.

CUBISM REVISITED

In this exercise, we'll see how easy it is to create cubes in any orientation in three-dimensional space. Let's start by creating a new brush:

- ☛ Clear the screen. Click the Grid icon to turn on the Grid. Command-click the Fill icon and click Solid and then OK (to get a solid fill).

Select the Filled Rectangle tool and a foreground color that contrasts with the current background color. With the Shift key held down (to constrain the rectangle to a square), draw a square about two inches wide. Select a new foreground color and draw a second square inside the first.

Now let's pick up the square as a brush and move it into Perspective mode:

- Click the Brush Selector; then pick up the square using the Command key and the mouse button. Try not to pick up any background color when you pick up the square. From the Edit menu, select Brush Handle to move the arrow cursor to the lower right corner of the brush. Select Perspective from the Brush menu (or press **Enter** on the keypad) to enter Perspective mode.

Our first job in perspective is to reset all axes to zero and to redefine the perspective center:

- Press Keypad **0** to reset the axes. Then press the **Decimal Point** on the keypad and set the perspective center to the center of the page, about one third of the way down.

When the grid is on in Perspective mode, the size of the grid defaults to the brush dimensions, i.e., the grid's x and y dimensions correspond to the brush's x and y dimensions. In addition, the grid's z dimension corresponds to its y dimension. You can change these settings by Command-clicking the Grid icon while you are in Perspective mode, but for this exercise we want to use them just as they are, because that is the best setting for creating cubes.

- Move the brush outline to the bottom left side of the screen and click the mouse button to place an image there. Note that since the Grid is on, DeluxePaint lets you place an image only at certain places on the screen (along Grid lines).

You have just created the front face of the cube. Next, we need to rotate the brush about its y-axis to create the right face of the cube:

- Press **Shift Keypad 4** to rotate the left side of the brush back 90 degrees. Without moving the brush, click the mouse button to place an image there. Then press **Shift Keypad 5** to rotate the brush back to its original position.

We have just built two sides of the cube. Now let's put a top on it:

- Without moving the brush left or right, slide it up one Grid position ("notch") so it is directly above the first side of your cube. Press **Shift Keypad 8** to rotate it 90 degrees about its x-axis. Click the mouse button to paint the top on the cube.

You probably noticed that the above construction involved minimal mouse movement. This is because with Grid turned on and the handle at the lower right corner of the brush, you only need to move the mouse two or three times. All rotations are about the brush handle, which automatically places the sides of the cube in their correct positions. Now that you have the rudiments down, try stacking cubes on top of each other, or stacking them side by side. Because you are in three-dimensional space, the possibilities are almost endless.

A ROW OF STately HOMES

For this exercise, load the brush called **Building** and select Use Brush Palette from the Color menu. Recenter Perspective mode by pressing **Enter** on the keypad. We will be rotating the brush about its y-axis to provide a view of a building from the side. In addition, we'll be resetting the perspective center to provide a "street-level" view.

- Clear the screen. Turn off the Grid, and turn off Brush Handle on the Edit menu. Press **Keypad 0** to reset all three axes to zero, and then press the **Decimal Point** key on the keypad to reset the perspective center. Move the large crosshair to about one inch from the bottom and about one inch from right-hand edge of the page (near the Palette) and click the mouse button.

Now we'll rotate the brush about its y-axis:

- Position the brush outline so that its center coincides approximately with the center of the page. Press **Shift Keypad 5** to rotate the brush 90 degrees about the y-axis. Move the brush to the left-hand side of the page. When you can just see the left-hand edge of the brush outline (i.e., just before it disappears off the left-hand side of the page), click the mouse button.

You have just painted the first of a row of buildings. To complete the row, move your brush so that its left edge coincides with the first building's right edge and place an image there. Continue this process until you have completed the whole row. As before, you may want to clean up the jagged edges a little. You could also "turn off" some of the lights by painting them a different color. You're the architect. You can even turn your buildings into highrises if you like. Just add a second layer on top of the first.

ANOTHER POINT OF VIEW

When we built our row of homes, we placed the perspective center (the viewer's eye level) toward the bottom right-hand corner of the page. This resulted in a row of homes as they would appear from street level. We could have placed the perspective center near the top of the page and created a row of buildings viewed from a higher plane. As an exercise for yourself, go back and recreate the row of buildings, but this time place the perspective center about one inch from the top of the page rather than the bottom. Press Keypad 0 to reset the axes, move the brush outline to the center of the page as before, press Shift Keypad 5 to rotate the brush 90 degrees about the y-axis, and click the mouse button to paint. This time the buildings will appear to be viewed from above.

FIXING AXES AND OTHER MYSTERIES

We have already seen how mouse movement translates into movement along the brush's x- and y-axes, and that this continues to be the case after the brush is rotated. We have also seen how to position a brush on its z-axis by controlling the position of the brush when you rotate it, and by using the apostrophe and semicolon keys to fine-tune that position after rotation. Now it's time to examine these concepts a little more closely.

The reason movement along a brush's z-axis is controlled by brush position at the moment of rotation (and by the apostrophe and semicolon keys after rotation) is simply that the mouse is only capable

of two-dimensional movement. Lifting the mouse off the table (the third dimension) has no effect onscreen, and so it is necessary to fix one axis with respect to mouse movement. When you first enter Perspective mode, the brush's z-axis is fixed, which means that mouse movement controls movement only along the brush's x- and y-axes. This, however, is only the default mode; you can selectively fix any one of the three axes, and allow mouse movement to control the other two. And as you might expect, brush placement (and the apostrophe and semicolon keys) controls movement along the fixed axis, whichever one that might be, just as it did when the z-axis was fixed. To see how this works in practice, try the following simple exercises:

- ☛ Clear the screen. Place the perspective center at the center of the page. Reset the brush rotation to zero by pressing **Keypad 0**, and move the brush outline so that its center coincides with the perspective center.

To fix the x-axis, press **Shift Keypad 9** (remember, the top row of the keypad controls the x-axis).

Now when you move the mouse, your brush will move along the y- and z-axes. Try it and see. If you move the mouse to the right of center, it gets larger; if you move it left again (back toward the center of the screen), it gets smaller. This is because side-to-side movement now controls movement along the brush's z-axis, the one perpendicular to the screen. On the other hand, moving the mouse backward and forward (toward you and away from you) has no effect on brush size, because this simply moves the brush along its y-axis. As you've probably guessed by now, this is an easy way to resize a brush: fix the x-axis, move the brush horizontally until it is the right size, and then click the button. Similarly, you can rotate a brush simply by rotating it about its z-axis (the bottom row of the keypad).

Press **Keypad 0** to reset the axes and to refix the z-axis. Now try fixing the y-axis (**Shift Keypad 6**) and doing the same thing. This time, backward-and-forward mouse movement controls movement along the brush's z-axis, while side-to-side movement controls movement along the x-axis. To fix the z-axis again, press **Shift Keypad 3**.

CITY PLANNING

Let's try our new axis-fixing skills on some city planning, and create an entire city with a single brush. Here's how:

- Reset all axes to zero (Keypad 0) and place the perspective center at the center of the page and about one inch from the top. Move the brush outline so that its *top* coincides with the perspective center (i.e., about one inch from the top). Press Shift Keypad 6 to fix the y-axis.

By fixing the y-axis, backward-and-forward mouse movement now controls movement along the brush's z-axis. You can now stamp buildings all over the page, and they will vary in size in accordance with their location on the screen's vertical axis. Note, however, that as you stamp buildings on the page, their tops stay at approximately the same height on the page. This is because the top of the brush coincided with the perspective center when you fixed the y-axis. You can change this now by shifting the brush along its y-axis, as follows:

- Hold down the Shift key and press the ' (apostrophe) key. This moves the brush along its (fixed) y-axis, moving it down below eye level.

Now as you move the brush up and down the page, the top of the brush moves up and down as well. Thus, by using the apostrophe key, you can fine-tune the brush's location on its fixed axis, changing its position relative to the viewer's point of view.

Note, however, that you can control this effect another way, just as we did when we rotated the brush in the first exercise. When you fixed the y-axis above, the top of the brush outline was level with the perspective center. If the brush outline had been towards the bottom of the page when you fixed the y-axis, the result would have been different. Try it. Reset all the axes to zero, move the brush to the bottom of the page, and fix the y-axis. Now as you move the brush up and down, its top moves as well. This illustrates the second important rule of perspective:

The location of the brush outline at the time you fix an axis determines the position of the brush on its fixed axis relative to the view plane.

CHAPTER THREE: TUTORIALS

Try the following as an exercise for yourself: reset the perspective center to a point about two thirds down the page, and then fix the y-axis in a way that allows the *bottom* of the buildings to be approximately level, providing more of a street-level perspective. (Hint: the same principle applies that applied in the previous exercise when we fixed the tops of the buildings).

Congratulations! You have just completed a series of tutorials designed to make you a **DeluxePaint** power user. But while the preceding tutorials cover most of **DeluxePaint's** important features, they couldn't cover everything. If you need information on any feature not covered in the tutorials or any of the preceding sections, you can look it up in the following chapter, the Reference section.

CHAPTER FOUR: REFERENCE



NOTES



This chapter describes every one of the DeluxePaint's features. First, it discusses menu items, menu by menu; then tools in the Toolbox; and finally, keyboard commands and cursors. Refer to this chapter when you want to look up information quickly about a certain feature of the program.

1 MENU ITEMS

As you press down the mouse button and move the pointer horizontally across DeluxePaint's Menu Bar, one after another of the menus drops down to reveal its selection of options. Moving the cursor down the selection of options highlights each one. Releasing the mouse button when a menu option is highlighted selects that option. If the option name is followed by ellipses (...), a dialog box appears after you select the option. There, you type information or select additional options; then you click OK to accept your new information or Cancel to leave the dialog box without making any changes.

In many cases, you can select a menu item by using its keyboard equivalent. Keyboard equivalents, where available, are given in the descriptions that follow. You can find a table of keyboard equivalents at the end of the Reference Section and in your Reference Card. Before you use a keyboard equivalent, make sure the cursor is not pointing at the Menu Bar, or your keystroke will have no effect. One keyboard equivalent deserves special mention: a (the "Again" key) invokes your last menu option, whatever it may have been. For example, if your last menu option produced a dialog box (e.g., a save or load dialog box), then pressing a produces the same dialog box.

The menus, reading from left to right across the Menu Bar, are as follows:

APPLE (🍏) MENU

The Apple menu gives you copyright information about **DeluxePaint** and lists your IIGS desk accessories.

ABOUT DELUXEPAINT...

Gives the name of the program, the date and version number, copyright information, and developers' names.

DESK ACCESSORIES

Lists the mini-applications that you currently have access to (such as a clock, calculator, or notepad). See your IIGS documentation for information about desk accessories.

FILE MENU

The File menu lets you load and save pictures, brushes, and stencils, and print pictures.

LOAD PICTURE...

Brings up the Load Picture Dialog Box (refer to Figure 1.4). To change to a different drive, click Disk. Click the name of the file you want to load. (If your file is in a folder, open the folder first by double-clicking.) If there are more items in the directory than there is room in the window, you can scroll through the directory by clicking the up and down arrows in the scroll bar or by dragging the scroll box up and down. If you change to a different drive or you swap disks while the Load Picture Dialog Box is displayed, **DeluxePaint** reads and displays the new disk's directory. Click Open to load the selected file, or Cancel if you change your mind.

SAVE PICTURE...

Brings up the Save Picture Dialog Box (refer to Figure 1.3). To change to a different drive, click Disk. You can save a picture by typing a filename (up to 15 characters long) in the Save Picture box. Click Save to save your file, or Cancel if you change your mind.

To create a new folder, type the folder name in the Save Picture box, then click New Folder. When the new folder name appears in the list, double click to open it. Then save your current picture in a file in the new folder by typing the filename and clicking Save.

Pictures are saved and reloaded with all their attributes, such as palettes, stencils, and perspective information. Note that the spare screen is not saved.

LOAD BRUSH...

Brings up the Load Brush Dialog Box. This is identical in function to the Load Picture Dialog Box (see above), except that you are loading a brush rather than a picture. If you load a brush that has a palette different from that of the current picture, the picture palette will remain in effect. Nonetheless, the brush palette information is loaded along with the brush; you can change to the brush's palette by selecting Use Brush Palette from the Color menu (see below). If you wish to revert to the previous palette, use Restore Palette, also from the Color menu.

SAVE BRUSH...

Brings up the Save Brush Dialog Box. It is identical in function to the Save Picture Dialog Box (see above). Brushes are saved with their palettes, which includes color cycling information.

LOAD STENCIL...

Stencils can be loaded (and saved, see below) as separate items. They are full screen only, and can be loaded only to the position they occupied when they were created. When loaded, stencils consist simply of a masked area and a "cut-out" area of the screen. You can lay down paint only on the cut-out area. The Load Stencil Dialog Box is identical to all other Load Dialog Boxes.

SAVE STENCIL...

You can save (and load, see above) stencils just as you can any other file, such as pictures or brushes. *DeluxePaint* saves your stencil as a "mask" with holes in it: The areas that were unlocked colors are the "cut outs" on the mask. *DeluxePaint* does not save any color information with the stencil. The Save Dialog Box for stencils is identical to those for other types of files.

CHOOSE PRINTER...

Lets you specify the printer you are using (such as ImageWriter or LaserWriter), and the port it is connected to (such as the printer port). Make sure all the information in this dialog box is correct before you use the Page Setup or Print options below.

PAGE SETUP...

Brings up the Page Setup Dialog Box, letting you specify how **DeluxePaint** will print your artwork on the page. For example, you can specify the size of the paper you are using and its orientation (that is, whether it will print upright or sideways). The options in the Page Setup dialog box may differ depending on the printer you have selected. Make sure the information in this dialog box is correct before printing your artwork using the Print option below.

PRINT...

Prints your current artwork. Make sure that your printer is connected and turned on; then click OK. Once your printer starts printing your artwork, you can stop printing by holding down the Command key and pressing the period (.).

QUIT

Leaves **DeluxePaint** and returns you to your previous environment.

EDIT MENU

The Edit menu lets you place **DeluxePaint** images on the IIGS Clipboard (to copy to other IIGS applications) and copy images from the Clipboard. It also lets you display additional information on the screen (Coordinates and the Info Bar) and make certain changes in your brush.

UNDO

Cancels the last drawing action. Same as Undo in the Toolbox.

CUT

Cuts an image and places it onto the Clipboard, replacing its previous contents. This allows you to move text or images between different applications. See your Reference Card for more information. See also Paste, below.

COPY

Copies an image and places it onto the Clipboard, replacing its previous contents. This allows you to move text or images between different applications. See your Reference Card for more information. See also Paste, below.

PASTE

Pastes the contents of the Clipboard (such as graphics or text from another application) into the current application. See your Reference Card for more information.

FAST FEEDBACK

As you draw with the Line or Unfilled Shape tools, gives you immediate feedback using the smallest (one-pixel) brush. Next, **DeluxePaint** completes the design using the currently selected brush. Use this to increase response speed while you are working with large or complicated brushes. Toggle Fast Feedback off by selecting it a second time.

COORDINATES

Turns on the coordinate display in the right-hand portion of the Info Bar. (You must, of course, first turn on the Info Bar.) Moving the mouse without holding a button down displays coordinates for the current position of the cursor, relative to the origin. Initially, the origin (0, 0) is set to the upper left-hand corner of the screen. Pressing and holding down the mouse button *temporarily* resets the origin to the current cursor position and displays the displacement value from that temporary origin when you move around the screen. (The readout is scaled in pixels.) If selected, Coordinates are displayed instead of Axis Rotation information in Perspective mode.

INFO BAR

Toggles the Info Bar at the bottom of the screen (see Figure 1.1). The Info Bar displays the following information:

PAINTING MODE: At the left of the Info Bar is the current painting mode (Matte, Color, Replace, Smear, Shade, Blend, Cycle, Smooth). See Mode menu, below, for information on painting modes.

COLOR FILL BOX: This box (in the left center of the Info Bar) displays the currently selected pattern fill, gradient fill, or perspective fill. This is the pattern or gradient fill you will get when you fill a shape. The Color Fill Box is absent if fill mode is set to Solid. See discussion under Fill tool, below, for more information on the Fill Type Dialog Box.

S: This notation appears in the center of the Info Bar when a stencil is active.

B: This notation appears in the center of the Info Bar when the background is fixed.

AXIS ROTATION: When you are in Perspective mode, the amount of rotation about each axis (x, y, and z, respectively) appears at the right of the Menu Bar. Axis rotation information does not appear if Coordinates is selected.

COORDINATES: When Coordinates (Edit menu) is selected, the coordinates of the cursor position are displayed at the right of the Info Bar. See the Coordinates option, above. If selected, coordinates are displayed instead of the Axis Rotation information in Perspective mode.

MEMORY AVAILABILITY: If you press the CTRL key and a at the same time, the amount of remaining memory is displayed at the left side of the Info Bar. See the Reference Card for information on DeluxePaint's memory usage.

BRUSH HANDLE

Lets you specify whether you'll hold your custom brush directly by its center (the default) or by a "handle" on one of its corners. Select Brush Handle if you want to hold your custom brush by a corner (as marked by the arrow cursor). The location of the handle depends on the direction you drag the mouse when you pick up the brush. If you drag down and to the right, the handle will remain at the lower right. If you drag up and to the left, the handle will move to the top left. The same principle applies if you drag down and to the left or up and to the right. In other words, the corner you drag *to* is the one the handle will attach to. Holding a brush by its Brush Handle is particularly useful in Perspective mode (see Brush menu, below).

To turn off Brush Handle and hold your brush by the center, select Brush Handle again (so it is not checked on the Edit menu).

EXCL BRUSH

If you pick up a brush with Excl Brush (and the Grid) selected, you will exclude a one-pixel border on the right and bottom edges (see Figure 4.1). This is useful if your brush has a colored border around it and you want to use the brush to create a pattern fill or perspective fill (using the Fill Type Dialog Box). When *DeluxePaint* creates your pattern, the border remains a uniform width throughout instead of being twice as wide where one copy of the brush is placed next to another.



*An image on
the screen*



*The image picked
up with
Excl Brush off*



*The image picked
up with
Excl Brush on*

Figure 4.1. An Example of Using Excl Brush (Assume Grid is On)

SQUARE ASPECT

Because the IIGS pixels are not perfectly square, squares and circles drawn with the shape tools are not perfectly square or round on the screen. (They will look better when printed, however.) If you wish to make any squares or circles you'll draw appear "true" on the screen, select Square Aspect from the Edit menu. This will square all the built-in brushes, the appropriate shape tools, and symmetry. Square Aspect does not square gridding or perspective.

PICT MENU

The Pict menu lets you work with stencils, backgrounds, and the spare page, and set screen resolution and page format. The Pict menu contains the following menu items:

PAGE SIZE...

Brings up the Set Page Size Dialog Box (see Figure 4.2). You can select the finished size of your painting (page size) that you wish to work on.

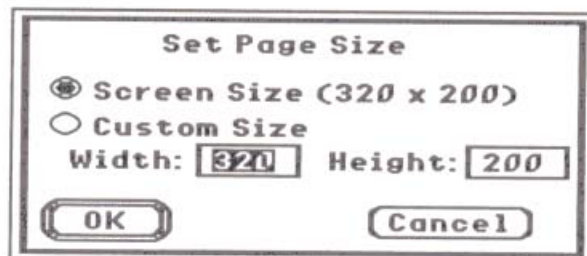

Figure 4.2. Set Page Size Dialog Box

Screen Size gives you a painting that is the size of your IIGS screen. Custom Size lets you specify your own page width and height. The maximum page size is twice the area of the screen. Examples of maximum page size in Medium Resolution are 320 x 400 and 640 x 200.

Click one of the two radio buttons — Screen Size or Custom Size. If you select Custom Size, also type the desired width and height (in pixels) in the appropriate boxes. Click OK when the Page Size is set as you want.

If your page size is larger than screen size, use the four Arrow keys to scroll to off-screen portions of the page. Or select Show Page (below) to see your entire painting on the screen in reduced form.

SCREEN FORMAT...

This brings up the Choose Screen Format Dialog Box (refer to Figure 2.3). This dialog box gives you the following options:

320 x 200, 16 colors: This is the default setting (called Medium Resolution). It gives you a pixel array of 320 x 200 and lets you have up to 16 colors on the screen.

640 x 200, 4 colors: This is the High Resolution setting. It uses a pixel array of 640 x 200 and allows 4 colors.

In general, you should decide on a screen format for your painting and continue with that format. You cannot change screen formats while your painting is on the screen, and you can only reload a picture in the format in which it was saved.

See the **Reference Card** for a discussion of memory requirements.

SHOW PAGE (Keyboard Equivalent: Shift-S)

Displays your current painting in its entirety in a reduced format — for example, with a 640 x 400 page size in Medium Resolution, it shows only every other pixel. Pressing any key or the mouse button returns you to your current painting in full size.

MAKE STENCIL...

Lets you create a stencil of an image by "locking" the colors that comprise that image. Then you can paint around the image without painting on it, as though it were protected by a stencil.

Selecting Make Stencil brings up the Make Stencil Dialog Box (see Figure 3.2). Click the colors to use in creating the stencil. A black vertical bar appears to the right of "locked" colors. These colors will define a mask that protects an area from being painted. You can select colors by clicking in the dialog box palette.

Clear the current color selections by clicking Clear. Reverse the colors in the dialog box that are locked by clicking Invert. When vertical bars appear to the right of all the colors you wish to protect, click Make. The letter S appears in the Info Bar when you have a stencil active. Note that the shape of the stencil (the mask) is what is created and stored in memory, not the color information, which means you can change the colors in the unmasked area, and still retain the stencil.

When you have a stencil active and you apply colors onto your picture, the colors you apply are not protected, even though they may be locked in the Make Stencil Dialog Box. You can lock newly-applied colors by bringing up the Make Stencil Dialog Box again and clicking Make.

REVERSE STENCIL

Reverses the *areas* on your screen that are locked. Does not depend on the color information in the Make Stencil Dialog Box. Suppose you lock the color blue in the Make Stencil Dialog Box and make a stencil. Later you toggle the stencil off and paint with blue on the part of your painting that is masked in your stencil. If you toggle the stencil on again and select Reverse Stencil, you reverse the masked and unmasked areas of your stencil and you can paint anywhere on the newly unmasked area (even in the blue areas). DeluxePaint "forgets" that you previously locked this color in the Make Stencil Dialog Box.

LOCK FOREGROUND

The Make Stencil Dialog Box lets you create stencils based on colors in the palette. By locking a color, you are making it impossible to paint on, *wherever it may be on the page*. By using a combination of Fix Background (see below) and Lock Foreground, however, you can define a stencil by area rather than color. (You don't need to use the Make Stencil Dialog Box.) When you select Lock Foreground, you lock those areas on the page that you have painted since fixing the background, regardless of the color of those areas. (In other words, those areas form the masked part of your new stencil.) When you lock a foreground, your subsequent painting is added *behind* the foreground and *in front of* your fixed background.

TOGGLE STENCIL (Keyboard Equivalent: ` to the left of the Spacebar)

Toggles the current stencil on and off. This lets you maintain the stencil in memory but turns it off temporarily so you can paint on the locked colors.

FREE STENCIL

A stencil uses memory even though the stencil is turned off (see Toggle Stencil, above). Free Stencil removes the stencil from memory.

FIX BACKGROUND

Fixes the background by "locking" the current picture, while allowing you to draw on top of it. You can erase any work you have done since fixing the background by clicking CLR or by painting while holding down the Command key and the mouse button. Fixing the background uses additional memory. Note that when the background is fixed, you cannot pick up any image painted before you fixed the background.

FREE BACKGROUND

This "unlocks" the background, so that clicking CLR will clear the entire picture. It also frees up the memory that was allocated to saving the background.

SPARE PAGE (Keyboard Equivalent: j)

Displays the spare page. (By definition, the spare page is always "the other page," the one that is not currently displayed.) Because you have two pages to work with, you can create brushes in one and import them to the other for final placement against a background. When you first call it up, the spare page is the standard screen size. If you wish to use a larger page size on the spare page, you will need to make the appropriate selection from the Page Size option (see above). Note, however, that you can increase the size of a page only if you have sufficient memory available. Note also that a spare page uses up memory, even if there is nothing on it.

COPY TO SPARE

Copies the picture on the current page to the spare page. This lets you experiment with your picture on the spare page without fear of losing anything. If you do not have sufficient memory for a spare page, save the image to disk if you wish to experiment with it.

DELETE THIS PAGE

If you no longer wish to have memory allocated for a second page, use Delete this Page to delete the current page (the one currently showing on the screen) and to deallocate the memory set aside for it. Be sure you have saved a copy of the picture you are deleting if you think you may need it later. When you select Delete this Page, **DeluxePaint** asks you to confirm the deletion, and then switches you to the other page.

MODE MENU

Lets you modify the way your brush lays down paint and lets you make subtle changes to paint that has already been laid down.

MATTE (Keyboard Equivalent: 1)

Uses a custom brush in its multicolor form. Those areas of the brush matching the current background color are transparent. This is the default mode when you create a custom brush using the Brush Selector. After you have used your brush with Color or Cycle, selecting Matte restores your custom brush in its previous multicolor form (assuming you haven't changed background colors).

COLOR (Keyboard Equivalent: 2)

Uses the shape of the custom brush and fills it with the current foreground color. Those areas of the brush matching the current background color are transparent.

REPLACE (Keyboard Equivalent: 3)

Uses the custom brush in its original multicolor form (i.e., Matte, see above), except that no colors are transparent.

SMEAR (Keyboard Equivalent: 4)

With Smear selected, you can smear any colors on the page by dragging a brush over them. This is like smearing a wet oil painting with your fingers, so the bigger the brush, the more pronounced the effect. Smear uses only the colors under the brush, does not add any new colors, and does not depend on color ranges. Smear ignores the current brush color but uses its shape.

SHADE (Keyboard Equivalent: 5)

With Shade selected, you can create subtle shading effects on those colors in your picture that are in a cycle range. You select the range you want to work with by selecting a foreground color in that range. Then, if the color under your brush is in that range, Shade paints over the color under your brush with the next color in that range. (For example, if one of your ranges consists of white, pink, and red and you have selected a current foreground color in that range, you can paint over white with pink, and you can paint over pink with red, and so on.)

You can paint with the next-higher color in the range by pressing the mouse button, and the next-lower color by holding down the Command key and the mouse button. "Higher" and "lower" are relative to the color under the brush at the time. If the current foreground color is in a cycle range, Shade has no effect on colors outside that range. If the current foreground color is *not* in a cycle range, Shade paints over all colors under the brush, treating the entire palette as a cycle range. If the current foreground color is a member of more than one range, DeluxePaint selects the lowest numbered range.

BLEND (Keyboard Equivalent: 6)

Like Smear, above, Blend drags the colors under the brush and runs them together. Unlike Smear, however, Blend looks at the current foreground color and cycle ranges (as well as the colors under the brush). And instead of laying down only the colors under the brush (like Smear), Blend "averages" the colors under the brush and lays down these colors. Blend averages colors numerically depending on their order in the palette. For example, the "average" of Colors 7 and 9 is Color 8, regardless of whether Color 8 is red, black, or some other color.

You select the range you want to work with by selecting a current foreground color in that range. If the current foreground color is in the same range as the colors under the brush, Blend adds blending colors within that range. If the current foreground color is in a different range from the colors under the brush, Blend will have no effect on the page. If the current foreground color does not fall within any color range, Blend uses blending colors throughout the entire palette.

CYCLE (Keyboard Equivalent: 7)

Uses the current brush shape and cycles through all the colors in the currently selected range *as you draw*. A range is selected if one of its members is selected. If a color is a member of more than one range, selecting it selects the lowest-numbered range. If your current brush color is not within a cycle range, **DeluxePaint** paints with that color only. Using Cycle with a multicolored brush treats the brush as if it were a single color (the current foreground color) and then cycles through that range.

Using Cycle *and* Multi-Cycle (below) with a multicolored brush causes each color in the brush to cycle through its range independently of the others, as you draw.

Note: The Cycle option in the Color menu has a different function: It turns on a flashing animation effect in the painting that is already on the screen.

SMOOTH (Keyboard Equivalent: 8)

Reduces the contrast between two adjoining areas (without depending on the current foreground color or cycle ranges). Smooth looks at the colors under the brush, finds one or more colors anywhere in the palette that fall on the color spectrum between the colors under the brush, and paints the boundary in these colors. Smooth doesn't average colors numerically like Blend, but averages colors based on their RGB/HSV settings. For instance, if averaging light and dark blue, Smooth will look on the palette for the color closest to a medium blue. If the palette contains a wide selection of colors close to the ones under the brush (e.g., the selection of blues), Smooth will have more colors to draw from to create its weighted averages. Useful for creating airbrush effects by smoothing out contrasting boundaries, or for eliminating jagged edges.

MULTI-CYCLE

Use this in conjunction with Cycle (see above). When Multi-Cycle is turned off (the default state), using the Cycle paint mode with a multicolored brush treats the brush as though it were a single color (the current foreground color). With Multi-Cycle turned on, painting with a multicolored brush in Cycle mode cycles every color in the brush, provided the brush color is in a cycle range. Note that Multi-Cycle actually alters the colors in a brush, so be careful! After you select Multi-Cycle, you cannot restore the previous version of your brush.

BRUSH MENU

The Brush menu lets you modify custom brushes (i.e. resize, flip, rotate, and bend) and create three-dimensional paintings (using the Perspective option).

FLIP HORIZONTAL (Keyboard Equivalent: **x**)

Flips the current brush along the horizontal or x-axis.

FLIP VERTICAL (Keyboard Equivalent: **y**)

Flips the current brush along the vertical or y-axis.

ROTATE

Lets you rotate your current brush any number of degrees. Hold down the mouse button and drag the rectangular outline to rotate it about its bottom left corner; release the button at the desired orientation. If you select this option more than once, your brush will revert to its original orientation before you rotate it again.

STRETCH (Keyboard Equivalent: **Shift-Z**)

Lets you stretch your brush in any direction to any size, larger or smaller than the original. Hold down the mouse button and drag in any direction to stretch the brush. Release the button when the brush is the desired size. You can constrain the stretching so that the ratio of height to width remains the same by holding down the Shift key as you stretch. Stretching a brush uses up memory; if you try to stretch a brush to a size bigger than the available memory can accommodate, the brush will snap back to its original size.

HALVE (Keyboard Equivalent: **h**)

Reduces the size of your brush by 50% in both dimensions.

DOUBLE (Keyboard Equivalent: **Shift-H**)

Doubles the size of your brush in both dimensions, for a quadrupling of the total area.

BEND HORIZONTAL

Lets you bend the current brush in a horizontal direction. With the mouse button held down, drag the brush outline left or right until it is

the desired shape and release the button. Dragging the cursor up or down determines where the bending occurs.

BEND VERTICAL

Lets you bend the current brush in a vertical direction. With the mouse button held down, drag the brush outline up or down until it is the desired shape and release the button. Dragging the cursor left or right determines where the bending occurs.

SHEAR

For controlled distortion of the current brush. The top part of the brush is anchored, and you can drag the bottom of the brush in either direction.

OTHER BRUSH FUNCTIONS:

You can select the following two brush sizing functions only through the keyboard:

DOUBLE HORIZONTAL (SHIFT-X)

Doubles the size of your brush in the horizontal dimension.

DOUBLE VERTICAL (SHIFT-Y)

Doubles the size of your brush in the vertical dimension.

Note: When you modify a brush (e.g. Halve it) and then want to restore your previous brush, Command-click the Brush Selector, or press **Shift-B**.

PERSPECTIVE

This operates only when you have a custom brush currently active. When you select Perspective on the Brush menu (or press Enter on the keypad), a perspective center is shown and your brush temporarily changes into a four cell matrix (the Perspective Brush outline). You can then rotate this brush outline about any or all of its three axes *x*, *y*, and *z* (see Figures 3.3 and 3.4). The amount of rotation for each of the three axes is given in degrees at the right-hand side of the Info Bar. (To display this, you must have the Info Bar displayed and Coordinates turned off.) You can paint an image of the rotated brush at any time by clicking the mouse button.

Note: Many perspective functions are performed with keys on your keypad. If you don't have a keypad, see your Reference Card.

SETTING THE CENTER: To set the perspective center (which corresponds to the viewer's eye level), press the Decimal Point key on the keypad. Your cursor changes into a large crosshair. The smaller stationary crosshair on the screen denotes the existing center. Move the center of the large crosshair to the desired perspective center and press the mouse button.

Once you have set the perspective center, the position of the unrotated brush relative to that center determines the brush's position on the fixed axis (see below) upon rotation. For example, with the z-axis fixed (the default), the position of the brush outline relative to the perspective center when the brush is rotated determines the rotated brush's position on its z-axis. The greater the distance above or below eye level on the z-axis, the more pronounced the perspective effect.

AXIS ROTATION: All x-axis manipulations are controlled through the top row of the keypad. To rotate the brush about its x-axis so that the top of the brush moves away from you, press **Keypad 8** for each degree of rotation. To rotate the brush about the x-axis in the opposite direction (so that the top of the brush moves towards you), press **Keypad 7**. To return to zero rotation for that axis, press **Keypad 9**.

All y-axis manipulations are controlled by the middle row of the keypad. To rotate the brush about the y-axis so that the right side of the brush moves away from you, press **Keypad 5**. Press **Keypad 4** to rotate the brush in the opposite direction, and press **Keypad 6** to return to zero rotation for that axis.

All z-axis manipulations are controlled by the bottom row of the keypad. To rotate a brush clockwise about the z-axis, press **Keypad 1**. Press **Keypad 2** to rotate the brush counterclockwise about the z-axis, and press **Keypad 3** to return to zero rotation.

To rotate about an axis through a larger increment, hold down the Shift key as you press the appropriate number. This increment defaults to 90 degrees, but you can set it to any other angle by calling up the Grid Dialog Box when in perspective mode. To do this, Command-click the Grid icon. See discussion below under The Toolbox. Pressing **Keypad 0** resets all three axes to zero and fixes the z-axis (see below), but retains the apparent distance settings. Pressing **Keypad 0** in conjunction with the Shift key resets all perspective values to the default (boot-up) state, including resetting the perspective center.

The ; and ' keys move the brush plane forward or back along its fixed axis (see below) without changing its orientation, moving it in a direction perpendicular to the brush plane. This has the same effect

described in the above discussion on brush position prior to rotation. Thus, with the z-axis fixed, brush position relative to the perspective center at the moment of rotation determines the brush's distance above or below eye level. You can achieve the same effect after the brush is rotated by using the ; and ' keys to move it forward or back along its z-axis. Pressing these keys with the Shift key held down results in larger increments of movement. In addition, you can modify the apparent distance from the observer by pressing the < and > keys (i.e., the Shifted "," and "." keys). Thus, when the apparent distance is great, the perspective foreshortening is at a minimum, becoming greater as apparent distance decreases.

FIXING AXES: Whenever you start in perspective mode, the z-axis (the one perpendicular to the screen) is "fixed," that is, the mouse does not move the brush along that axis. You can selectively fix any axis, as follows:

- To fix the x-axis, press **Shift-Keypad 9**
- To fix the y-axis, press **Shift-Keypad 6**
- To fix the z-axis, press **Shift-Keypad 3**

As noted above, you can move along the axis that is currently fixed by using the Shifted or un-Shifted ; and ' keys (use the Shifted keys for larger increments).

The position of the brush outline at the moment you fix an axis is also important. For example, if the center of the brush outline corresponds exactly to the perspective center at the moment you fix the y-axis (which causes back-and-forth — toward you and away from you — mouse movement to translate into movement along the screen's z-axis), then movement along the z-axis will be at eye level, so the brush outline will simply become bigger or smaller as you move the mouse back and forth. On the other hand, if the top of the brush outline is below eye level at the moment you fix the y-axis, then movement along the z-axis will be on a plane below eye level.

Once you have rotated the outline to the desired orientation, you can place a copy of the modified brush on the page by clicking the mouse button. The other brush options work in Perspective mode as well, including the options available through the Brush menu (see above). For example, if you want to hold your brush outline by the corner rather than the center, you can select Brush Handle from the Edit menu. This moves the arrow cursor to the lower right corner of the brush. When you rotate a brush about an axis, it is rotated about the arrow cursor, so its location is important when you are in Perspective mode.

You can also fill any enclosed space with perspective fill. In Perspective mode, rotate your brush as desired. Then Command-click the Fill tool to bring up the Fill Type Dialog Box (refer to Figure 2.6, above) and click on Perspective. From that point on (until you turn it off by clicking another Fill type), any fill operation (using either the Fill tool or the Filled Shape tools) will use perspective fill.

EXITING PERSPECTIVE MODE: To exit Perspective mode, click one of the drawing tools.

KEYBOARD COMMANDS: For a list of the keyboard commands available in Perspective mode, see Keyboard Commands and Cursors, below.

OPTIONS...

Displays the Perspective Options Dialog Box, which lets you change rotation modes and toggle anti-aliasing on and off (see Figure 4.3).



Figure 4.3. Perspective Options Dialog Box

The Perspective Options Dialog Box provides the following options:

ROTATION

Absolute: Default; uses x, y, z Euler method, measures all three angles of rotation from absolute zero. Angles of rotation are displayed on the Info Bar.

Relative: Rotates angles relative to the current brush rotation. Angles of rotation are not displayed on the Info Bar.

ANTI-ALIASING

None: Default; anti-aliasing is off.

Low: Lets you eliminate some of the jagged outline on your perspective brush. Jagged lines are most noticeable when an image has been rotated and/or shrunk. The brush will be painted more slowly than with anti-aliasing off. To use anti-aliasing, select either Low or High (see below) before you lay down the brush image. Anti-aliasing is most effective when you have reduced the size of your original brush (for example, by moving it back along the z-axis).

High: This is similar to Low (see above) but with a much more pronounced effect. The brush will be painted much more slowly than with anti-aliasing off.

COLOR MENU

The Color menu lets you modify your current palette and load various other palettes.

PALETTE... (Keyboard Equivalent: p)

Brings up the Palette Window (refer to Figure 2.4). You can also bring up the Palette Window by Command-clicking the Color Indicator (between the Main Palette and the Toolbox). This window lets you modify your palette and set color ranges. To start working with a color, click the color in the mixing palette. The black rectangle (called the Color Selector) will move to the color you select. Move the scroll boxes in the RGB (for Red, Green, and Blue) or HSV (for Hue, Saturation, and Value) scroll bars to change the color.

To get numerical R, G, B, H, S, and V settings, press the **n** key when the Palette Window is displayed. This brings up the Color Settings Dialog Box (Figure 4.4). Here, the scroll box positions on the R, G, B, H, S, and V scroll bars are converted to numbers. The numbers range from 0 to 15 for R, G, and B and from 0 to 255 for H, S, and V. The numerical settings for a pure red are shown below. To duplicate a color on a later palette or on a different computer, display this dialog box and write down the numerical settings for that color.

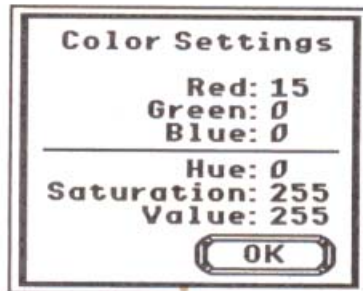

Figure 4.4. Color Settings Dialog Box

DeluxePaint uses Colors 1 and 16 to draw dialog boxes and the Toolbox. Therefore, it does not allow you to select similar colors for Colors 1 and 16 (such as black and dark blue) or you wouldn't be able to read the dialog boxes, etc.

To copy a color from one position to another, click the first color, click Copy, then click the position you want to copy it to. To swap the position of two colors, click the first color, click Swap, and then click the second color. If you use this to rearrange colors in your Palette and find that the colors in your painting are scrambled, use the Remap Pict option to return the picture to its original appearance (see Remap Pict below). To create a spread of shades between two colors, click the first color, click Spread, and then click the second color. **DeluxePaint** creates a uniform spread of colors, taking into account the beginning and ending shades and the number of colors in between.

The Range feature controls color cycling, gradient fill and Shade and Blend. You can create four color ranges using the Range command. Click one of the four radio buttons after Range (1, 2, 3, or 4), then move the ends of the bracket that is at the right of the mixing palette. To change a range, simply repeat the process. To cancel a range, create a range of one color: that is, move the ends of the bracket until they both point to only one color. Once you have defined a range of colors, selecting any of the colors in the range selects the entire range.

You can control the speed of the color cycling for each range by dragging the Speed scroll box to the left (slower) or to the right (faster). By holding the mouse button down on the scroll box, you can monitor the color cycling speed on the page, even if Color Cycling is turned off. You can control the cycle direction for each range by clicking on one of the two cycle direction arrows to the right of the Speed scroll box while that range is selected.

You can reverse the last change you made in the Palette Window by pressing **u** on the keyboard. To accept your changes and return to your painting, click OK. (Clicking outside the Palette Window has the same effect as clicking OK.) If you don't wish to use any of the changes you've made, click Cancel to return to the page as you left it. If you accept your changes and then decide to return to the previous palette, select Restore Palette from the Color menu (see below).

RESTORE PALETTE

This returns you to the palette you were using before the current palette. Thus, if you load a picture with a different palette, Restore Palette reverts to the palette in effect before the load. See Use Brush Palette and Default Palette below.

DEFAULT PALETTE

The default palette is the one **DeluxePaint** always uses when you first start the program. The Default Palette command replaces the current palette with the default palette.

CYCLE (Keyboard Equivalent: Tab)

Toggles color cycling on/off in your painting (see Palette, above). Here, the colors already on the screen cycle through their respective ranges, and a flashing animation effect is created. If a color is not included in any range, it does not cycle. See Animation with Color Cycling at the end of Tutorial 1 in Chapter 3.

To cycle through colors *while drawing with a custom brush*, use Cycle and Multi-Cycle in the Mode menu.

BACK->FORE PICT

Changes the color currently designated as the background color to that currently designated as the foreground color. This provides an easy method of changing colors throughout the page — that is, all pixels in the current background color in the picture are changed to the current foreground color. Use this option, for example, if you simply want to change all occurrences of light blue in your painting to a darker shade of blue from your palette. The change occurs onscreen only and does not affect the order of colors in the Palette. Undo does not reverse this change.

BACK<->FORE PICT

Swaps all pixels in the current background color with the current foreground color. This is similar to the Back->Fore Pict option above,

except that the change occurs in both directions. This option changes the colors in your painting only and does not change the order of colors in the Palette. Like Back->Fore Pict, above, Undo does not reverse this change.

REMAP PICT

When you create a picture, **DeluxePaint** "remembers" each color on the screen by remembering its location in the palette. If a picture on the screen was created with a palette other than the current palette (for example, if you modified the palette since loading the picture), Remap finds the locations in the current palette of the colors it used in the original palette and "tells" the picture to look there for its colors. Back->Fore Pict and Back->Fore Pict, above, are special cases of Remap. See also Remap Brush, below. Undo does not reverse this change.

USE BRUSH PALETTE

When you load a brush, **DeluxePaint** continues to use the current picture palette, even though it may be different from the one the brush was created with. Use Brush Palette switches to the brush palette, and includes any information about color cycling that was saved with the brush. Remap Brush, below, lets you keep the current picture palette, but maps the brush to the picture palette for a best fit.

BACK->FORE BRUSH

Changes all pixels in the brush of the color currently designated as the background color into that currently designated as the foreground color. This provides an easy method of making a global color change — all instances of the background color in the brush are changed to the current foreground color. You can select any color in the brush as either the foreground or the background color at any time, thereby letting you make intricate color changes easily. The change affects the brush colors only and does not affect the picture or the order of colors in the Palette.

BACK<->FORE BRUSH

Swaps the current background color in the brush with the current foreground color. This is similar to the Back->Fore Brush option above, except that the change occurs in both directions. The change affects the brush colors only and does not affect the picture or the order of colors in the Palette.

REMAP BRUSH

Use Remap when you load a brush that uses a palette different from the current palette. Remap looks at the colors used in the brush and tries to find the closest fit within the current palette. Different from Use Brush Palette, because it does not change the palette, but only the palette locations the brush looks in for its colors.

FONT MENU

Lets you select fonts and styles (e.g., plain, bold, or underlined) for text. To enter text, press **t** from the keyboard or click the Text Icon on the Toolbox. See discussion on the Toolbox below for more information.

PLAIN

Returns to the regular (plain) style from bold, outline, and/or underline. This is the default style.

BOLD

Toggles boldfacing on/off. When on, **DeluxePaint** paints the current font in boldface. Selecting Bold a second time turns it off.

UNDERLINE

Toggles underlining on/off. When on, **DeluxePaint** paints the current font underlined. Selecting Underline a second time turns it off.

OUTLINE

Toggles outline text on/off. When on, **DeluxePaint** paints the current font outlined. Selecting Outline a second time turns it off.

8 POINT, 10 POINT ... 16 POINT

Selects font size.

FONTS

Lets you choose from the available fonts. Select a font by highlighting it and releasing the mouse button.

2 TOOLBOX (refer to Figure 1.2)

Like some of the menu items above, most of the tools in the Toolbox are available through keyboard equivalents. As you become proficient with **DeluxePaint**, you will find it more efficient to use these equivalents, using one hand for the mouse and the other hand for the keyboard. Where appropriate, the following descriptions of the tools include the keyboard equivalents. And to help you learn these, we have suggested a mnemonic for each one.

BUILT-IN BRUSHES

The Toolbox contains ten built-in brushes at the top. Click a brush to select it. Command-click to invoke the size option. To increase the size of the selected brush, drag the mouse while holding down the mouse button; to decrease the brush size, drag the mouse while holding down the Command key and the mouse button.

DOTTED FREEHAND TOOL

(Keyboard Equivalent: **s**; Mnemonic: **sketch**)

Draws a series of "splats" of the current brush shape. Spacing between splats is a function of the speed with which you move the mouse.

CONTINUOUS FREEHAND TOOL

(Keyboard Equivalent: **d**; Mnemonic: **draw**)

Draws a continuous freehand line.

STRAIGHT LINE TOOL

(Keyboard Equivalent: **v**; Mnemonic: **vector**)

Draws a straight line using either the current foreground color (if you're holding down the mouse button) or the current background color (if you're holding down the Command key and the mouse button). Press and hold the button while you drag the mouse to the line's end position and then release the button.

Holding down the **Shift** key while drawing with this tool constrains lines to horizontal and vertical lines only. Holding down the **CTRL** key while using this tool causes **DeluxePaint** to paint traces as you draw. This means that **DeluxePaint** not only draws your final line but also puts down in your painting all the intermediate lines that appeared on the screen as you were dragging the mouse.

Command-clicking the icon brings up the Spacing Dialog Box (refer to Figure 2.5). The Spacing Dialog Box lets you specify the space

between the paint "splats" deposited by the brush to produce a dotted line. Absolute spacing sets the number of pixels between each splat of the brush. Relative spacing defines the total number of splats that will occur along the line. You can define the number of splats by clicking the Number box, deleting the existing value, and typing the new value. Click On if you wish to have spacing on (an X appears in the box). Click the On box again to turn spacing off. When Spacing is on, it is also in effect for the Curve tool and the Unfilled Shape tools.

CURVE TOOL

(Keyboard Equivalent: q; Mnemonic: **q**urve)

Draws an arc. Draw a line between the beginning and ending points of the arc as though you were using the Straight Line tool (see above) and release the mouse button. Then drag the line until the arc is the right shape, and click the button. Holding down the CTRL key while using this tool causes DeluxePaint to paint traces as you draw. Command-clicking the icon brings up the Spacing Dialog Box (see above).

FILL TOOL

(Keyboard Equivalent: f; Shift F: Fill Type Dialog Box; Mnemonic: fill)

Select the Fill tool by clicking the icon. The spout of the Fill tool is the bottom of the dripping paint. The Fill tool fills an enclosed area of any color with the current color or pattern. Command-clicking the icon brings up the Fill Type Dialog Box (refer to Figure 3.1). You can fill enclosed objects with the following: Solid, Perspective, Pattern, or one of three types of Gradient fill. 1) **Solid** fills with the current color; 2) **Perspective** fills with the pattern made from your brush in the Perspective mode (see Perspective under the Brush menu, above); 3) **Pattern** fills with the pattern made from the current brush in standard mode. (To create a pattern to use for Pattern fill, first select Get Brush. This creates a pattern from your current brush and displays it to the right of the Get Brush button.)

4) **Gradient** fills with a spread of colors from the cycle range of the current foreground color. Click one of the three Gradient options with the mouse button: **Horizontal Fill** (the top Gradient button) lays the gradient horizontally from top to bottom. **Vertical Fill** (the middle Gradient button) lays the gradient vertically from left to right with an even distribution. **Horizontal Line Fill** (the bottom Gradient button) lays the gradient left to right one line at a time, adjusting the gradient on each line so that it follows the contours of the shape being filled. You can specify the direction of the gradient fill (that is, the colors in the cycle range DeluxePaint begins filling with) by clicking the appropriate Cycle Direction Arrow in the Palette Window.

Dither controls the degree of mixing of colors in the gradient fill. Move the Dither scroll box by sliding it left or right with the mouse button. Setting Dither all the way to the left gives you no overlap between each shade. Moving the Dither scroll box to the right increases the amount of "noise" between the color boundaries. When you return to the painting screen, the current gradient (or pattern, if Pattern or Perspective is selected) and its orientation are shown in the Color Fill box (see Info Bar in the Edit menu, above).

AIRBRUSH TOOL

Sprays with the current brush. Command-clicking the icon brings up the Size cursor (a box with a smaller box inside), which allows you to define the nozzle size and hence the spray area. To resize the brush, press the mouse button, drag, and release.

Note: The following Filled Shape tools all fill in accordance with the current settings in the Fill Type Dialog Box. See discussion under the Fill tool, above.

UNFILLED/FILLED RECTANGLE TOOL

(Keyboard Equivalent: **r** — Unfilled; **R** — Filled; Mnemonic: **rectangle**)

Click the upper left part of the icon to select Unfilled Rectangle and the lower right to select Filled Rectangle. Draw a rectangle by dragging diagonally on the page. The Unfilled Rectangle paints with the current brush (whether it is a built-in or custom brush). Holding down the **Shift** key while drawing with this tool constrains rectangles to squares. Holding down the **CTRL** key while using the Unfilled Rectangle causes *DeluxePaint* to paint traces as you draw. Command-clicking brings up the Fill Type Dialog Box (see above).

UNFILLED/FILLED CIRCLE TOOL

(Keyboard Equivalent: **c** — Unfilled; **C** — Filled; Mnemonic: **circle**)

Click the upper left of the icon to select Unfilled Circle and the lower right to select Filled Circle. Draw a circle by dragging diagonally on the page. The Unfilled Circle paints with the current brush (whether it is a built-in or custom brush). Holding down the **CTRL** key while using the Unfilled Circle causes *DeluxePaint* to paint traces as you draw. Command-clicking brings up the Fill Type Dialog Box (see above).

UNFILLED/FILLED ELLIPSE TOOL

(Keyboard Equivalent: **e** — Unfilled; **E** — Filled; Mnemonic: **ellipse**)

Click the upper left of the icon to select Unfilled Ellipse and the lower right to select Filled Ellipse. Press and drag to draw the ellipse; release. After you release, you can move the mouse to further define the *size and shape* of the ellipse. Then press and drag again to define the *rotation* of the ellipse. Release to draw the ellipse. Holding down the CTRL key while using the Unfilled Ellipse causes **DeluxePaint** to paint traces as you draw. Command-clicking the icon brings up the Fill Type Dialog Box (see above).

UNFILED/FILLED POLYGON TOOL

Click the upper left of the icon to select Unfilled Polygon and the lower right to select Filled Polygon. Click and drag to "tack" each point of the polygon down. Clicking your polygon's point of origin completes it. Or you can complete the polygon without having to search for the point of origin by pressing the Spacebar. Holding down the Shift key while drawing a side of the polygon constrains that side to a horizontal or vertical line. Holding down the CTRL key while using the Unfilled Polygon causes **DeluxePaint** to paint traces as you draw. Command-clicking the Polygon tool brings up the Fill Type Dialog Box (see above).

BRUSH SELECTOR

(Keyboard Equivalent: **b** for new brush, **B** for previous brush; Mnemonic: **brush**)

Allows you to 1) create a custom brush from any image (picture or text) on the page and 2) recall your most recent custom brush.

1) To create a new brush, click the Brush Selector tool once. Then, press the mouse button and drag diagonally on the page until the image is surrounded by a selection box. When you release the button, the image remains where it is *and* becomes your current brush. Any colors in the brush that match the current background color will be transparent. To lift an image off the background onto your brush, press the Command key and the mouse button, drag until your section is surrounded, and release the mouse button. When you lift an image, the space left behind will fill with the current background color. To pick up an image from a crowded area, click the Brush Selector twice (the Brush Selector icon becomes a diamond). Then, by dragging and clicking, draw a "corral" around your object, as if you were using the Polygon tool (see above). You can also use the Command key with the Corral feature.

2) To recall your most recent brush, Command-click the Brush Selector or press Shift-B.

TEXT

(Keyboard Equivalent: **t**; Mnemonic: **text**)

To create text, click the text icon ("A") in the Toolbox or type **t**, the keyboard equivalent. Change the current foreground color to the color you want for your text. From the Font Menu, select the desired font (such as Chicago 12 point) and style (Plain, Bold, or Underline). Click the mouse button where you want the text to begin.

Type your text from the keyboard. The text will automatically wrap around the right edge of the page and restart at the left margin, in alignment with the initial cursor position. Pressing Return starts a new line, in alignment with the original cursor position. Use the Delete key to erase on the current line. If your page size is larger than the screen, the page scrolls as you type off the edge of the screen. Note, however, that you cannot delete typed characters (by using the Delete key) once the screen scrolls. In that case, you would need to delete the text as you would any other image, by painting over it with the background color. Press ESC or click a drawing tool to exit Text mode.

GRID

(Keyboard Equivalents: **g** — grid on/off; **Shift-G** — grid on, aligned with brush location; Mnemonic: **grid**)

Grid constrains the action of the drawing tools. Command-clicking the Grid icon brings up the Grid Dialog Box (refer to Figure 2.1). Use the Grid Dialog Box to adjust the x and y Spacing of the grid. You can specify the grid values in pixels by deleting the existing values and typing in the new ones. Or you can click From Brush to set your grid to the dimensions of your brush. Alternatively, you can click the Adjust box, which lets you visually place and adjust the grid. Position the grid and then press the mouse button and drag to adjust the size. If you use **Shift-G** to turn the grid on while using a brush, the grid will use the current brush position as one of its points.

If you bring up the Grid Dialog Box while you are in Perspective mode, you will be able to specify the Spacing on all three axes x, y and z, in the same manner. Alternatively, you can click From Brush to set the x and y spacing to the current brush dimensions. (Z defaults to the same value as y). In addition, you can change the increment of rotation caused by the Shift key by specifying the new angle (between 2 and 89 degrees) in the Angle Step box. For example, if you set the Angle Step value to 45 (instead of the default 90), **DeluxePaint** rotates the brush 45 degrees about the x-axis every time you press the Shift key and Keypad 8. Three-dimensional gridding and incremental rotation make it easy to create solid figures, such as cubes and other polyhedrons. See Tutorial 4, *Cubism Revisited*, for a simple exercise using gridding.

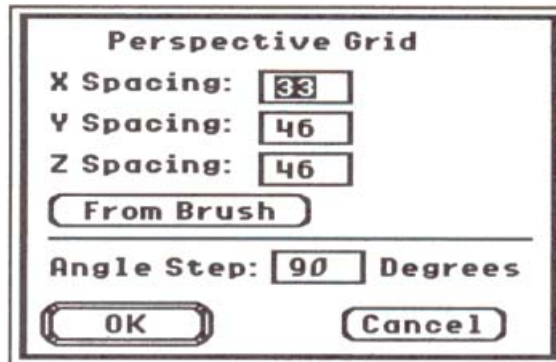

Figure 4.5. Perspective Grid Dialog Box

SYMMETRY

(Keyboard Equivalent: /)

Symmetry works with all tools except Text and Brush Selector. Command-clicking brings up the Symmetry Dialog Box (refer to Figure 2.2) where you can choose from two symmetry modes: Point and Tile. Point Symmetry works around a central symmetry point in either Mirror (mirror image duplication of each point) or Cyclic (duplication at each symmetry point). In Point Symmetry, you can select the number of symmetry points (up to 40) and the location of the symmetry center. Use Tile Symmetry to create 'tile' patterns. You can set the horizontal and vertical dimensions (in pixels) of the tile size. Tile is useful in creating fill patterns. Always start with a blank page when using Tile Symmetry. To cancel Symmetry, click the Symmetry tool again.

MAGNIFY

(Keyboard Equivalent: m; Mnemonic: magnify)

Click the icon to select the tool. Position the Magnify box over the part of the image you want to enlarge and click with the mouse button. To change the magnification scale, click the Up or Down Arrow inside the Zoom icon (to the right of the Magnify Tool): Clicking the Up Arrow enlarges the image, clicking the Down Arrow shrinks it. In the magnified and unmagnified areas, you can scroll around using the arrow keys or the n key, which moves the area under the cursor to the center of the magnified area. All other tools work in Magnify mode. To turn off Magnify when the magnified area is displayed, click the Magnify icon again, or press m.

ZOOM

(Keyboard Equivalent: > enlarge; < shrink)

Changes the scale in Magnify mode (see Magnify tool, above). Click the top left half of the Zoom icon (the Up Arrow) to enlarge the image, and click the bottom right half of the icon (the Down Arrow) to shrink it.

UNDO

(Keyboard Equivalent: **u**; Mnemonic: **undo**)

Reverses the last drawing action provided there has not been an intervening mouse click. For example, if you create a rectangle and immediately select Undo, *DeluxePaint* erases the rectangle from the screen. If you create the rectangle and then select another tool before you select Undo, *DeluxePaint* does not erase the rectangle.

CLR

(Keyboard Equivalent: **Shift-K** or the **Clear** key on the keypad; Mnemonic: **Klear**)

Clears the screen to the currently selected background color.

COLOR INDICATOR

Indicates the current foreground and background colors. Clicking the Color Indicator with the mouse button or pressing the comma (,) from the keyboard changes your cursor into four crosses, the Select Color cursor. This lets you select a new foreground or background color by clicking a color onscreen. Clicking the onscreen color with the Select Color cursor selects a new foreground color, and Command-clicking selects a new background color.

Command-clicking the Color Indicator brings up the Palette Window (refer to Figure 2.4).

PALETTE (also called Main Palette)

Clicking a color in the Palette (below the Toolbox) selects a new foreground color. Command-clicking selects a new background color. The current foreground and background colors are displayed in the Color Indicator.

3 KEYBOARD COMMANDS AND CURSORS

BRUSH COMMANDS

	1	Matte mode
	2	Color mode
	3	Replace mode
	4	Smear mode
	5	Shade mode
	6	Blend mode
	7	Cycle mode
	8	Smooth mode
	-	Reduce brush size
Shift	-	Reduce brush size twice as much as -
=	=	Increase brush size
Shift	=	Increase brush size twice as much as =
Z		Stretch
h		Halve
H		Double
x		Flip horizontal
X		Double horizontal
y		Flip vertical
Y		Double vertical
z		90 degree rotate

(For 1-8, use number keys on main part of keyboard, not keypad)

PERSPECTIVE COMMANDS

X-Axis Commands:

Keypad 7 and 8
Shift Keypad 7 and 8

Rotate about the x-axis
Rotate 90 degrees about the x-axis
(default)

Keypad 9
Shift Keypad 9

Reset x-axis to zero
Fix x-axis

Y-Axis Commands:

Keypad 4 and 5
Shift Keypad 4 and 5

Rotate about the y-axis
Rotate 90 degrees about the y-axis
(default)

Keypad 6
Shift Keypad 6

Reset y-axis to zero
Fix y-axis

CHAPTER FOUR: REFERENCE

Z-Axis Commands:

Keypad 1 and 2	Rotate about the z-axis
Shift Keypad 1 and 2	Rotate 90 degrees about the z-axis (default)
Keypad 3	Reset z-axis to zero
Shift Keypad 3	Fix z-axis

Other Commands:

Enter	Enter Perspective mode
Keypad . (Decimal Point)	Reset perspective center
Keypad 0	Reset all axes to zero
Shift Keypad 0	Reset all axes to zero and perspective center to default state
Keypad - (Minus)	Fill the screen with the current brush at the current perspective
; and '	Move the brush along the fixed axis in a direction perpendicular to the brush plane
: and " (Shift ; and ')	Same as ; and ' keys but with a greater increment
< and > (Shift . and Shift ,)	Modify observer distance from screen

Note: If your keyboard does not have a keypad, see your Reference Card.

TOOLBOX COMMANDS

b	Brush Selector tool; if clicked again, Corral tool
B	Restore last custom brush
c	Unfilled Circle tool
C	Filled Circle tool
d	Continuous Freehand tool
D	Continuous Freehand tool with 1-pixel brush
e	Unfilled Ellipse tool
E	Filled Ellipse tool
f	Fill tool
F	Fill Type Dialog Box
g	Grid
G	Grid to current brush position
j	Spare page
K	Clear page
m	Toggle Magnify tool

CHAPTER FOUR: REFERENCE

p	Palette Window
q	Curve tool
r	Unfilled Rectangle tool
R	Filled Rectangle tool
s	Dotted Freehand tool
t	Text
u	Undo
v	Straight Line tool
>	Zoom in (to enlarge magnified image)
<	Zoom out (to shrink magnified image)
,	Select Color cursor
[and]	Move Color Selector up and down the palette
.	One-pixel brush
/	Toggle Symmetry

PALETTE WINDOW COMMANDS

n	Display Color Settings Dialog Box
u	Undo last color change
1, 2, 3, or 4	Select Range 1, 2, 3, or 4
[and]	Move Color Selector up and down
<- and ->	Move top end of Range bracket up and down
↑ and ↓	Move bottom end of Range bracket up and down









SPECIAL KEYS

9	Toggle Info Bar
0	Toggle Menu Bar and Toolbox/Palette
ESC	Toggle cursor
<- and ->	Scroll page; in Text mode, move cursor
n	Center area under the cursor; In Magnify mode, move area under the cursor to center of magnified area
Shift	Constrain with Rectangle, Straight Line, and Polygon tools
CTRL	Leave traces with Line or Shape tools
CTRL a	Check memory
Tab	Toggle color cycle
S	Show page

(to left of Spacebar)	Toggle stencil
a	Repeat last menu option (Again key)
Spacebar	Abort current command

(For 9 and 0, use number keys on main part of keyboard, above alphabet.)

CURSORS

	Standard	Select items in Toolbox, Palette, and Dialog Boxes; draw with a custom brush
	Crosshatch	Draw with a built-in brush
	Text	Enter text
	Watch	Tell user to wait for completion of computer activity
	Fill Bucket	Fill closed object with a solid, pattern, perspective, or gradient fill
	Select Color	Change current background or foreground color by clicking an onscreen color; Select another color after using Copy, Swap, or Spread in the Palette Window
	Size	Change size of a built-in brush or the Airbrush
	Grid	Adjust size and alignment of current grid
	Perspective Brush	Move a custom brush in Perspective mode

NOTES

INDEX

INDEX

A

- Airbrush tool, 1.8, 4.27
 - modifying, 2.17
- Animation with color cycling, 3.10-3.11
- Anti-aliasing, 3.29, 4.19-4.20
- Apple (⌘) menu, 4.2
 - About DeluxePaint, 4.2
 - Desk Accessories, 4.2

B

- Back->Fore Brush, 3.14, 4.23
- Back<->Fore Brush, 3.14, 4.23
- Back->Fore Pict, 4.22
- Back<->Fore Pict, 4.22-4.23
- Background
 - color, 1.3-1.4
 - fixing, 1.15-1.16, 2.12, 3.23-3.24, 4.11
 - restoring, 1.15-1.16, 4.11
- Bend Horizontal command, 4.15-4.16
- Bend Vertical command, 3.13, 4.16
- Blend command, 2.20-2.21, 4.13
- Brush Handle, 2.4-2.5, 4.7
- Brush menu, 2.4, 4.15-4.20. *See also* Brushes
 - Bend Horizontal, 4.15-4.16
 - Bend Vertical, 3.13, 4.16
 - Double, 4.15
 - Flip Horizontal, 4.15
 - Flip Vertical, 4.15
 - Halve, 4.15
 - Options, 4.19-4.20
 - Perspective, 4.16-4.19
 - Rotate, 4.15
 - Shear, 3.12, 4.16
 - Stretch, 3.13, 4.15
- Brush Selector, 1.11-1.12, 2.2, 2.3, 4.28
 - effect on Background color, 2.3
 - modifying, 2.20-2.21
 - repositioning text with, 2.21-2.22
- Brushes. *See also* Brush menu
 - bending, 3.13
 - built-in, 1.6, 2.17, 4.25
 - changing colors of, 1.4, 2.4, 3.14
 - creating custom, 2.2-2.4
 - filling with pattern, 3.15
 - handle, 2.4-2.5, 4.7
 - keyboard command summary, 4.32
 - loading, 2.4, 4.3
 - modifying, 2.17
 - palette, 4.23

- resizing, 3.13, 4.16, 4.25
- rotating, 3.25-3.36
- saving, 4.3
- selecting complex shapes for, 2.3
- slanting, 3.12
- symmetrical, 2.9-2.10
- transparent background of, 2.3

C

- Choose Screen Format dialog box, 2.13, 4.9
- Circle tool, 1.10, 4.27
- CLR button, 1.4, 1.15-1.16, 2.12, 4.31
- Color command, 3.16, 4.12
- Color cycling, 2.16, 3.10-3.11
 - speed of, 3.11, 4.22
- Color Fill Box, 4.6
- Color Indicator, 1.4, 3.2, 3.14, 4.31
- Color menu, 4.20-4.24
 - Back->Fore Brush, 3.14, 4.23
 - Back<->Fore Brush, 3.14, 4.23
 - Back->Fore Pict, 4.22
 - Back<->Fore Pict, 4.22-4.23
 - Cycle, 3.11, 4.22
 - Default Palette, 1.15, 4.22
 - Palette, 4.20-4.22
 - Remap Brush, 4.24
 - Remap Pict, 4.23
 - Restore Palette, 4.22
 - Use Brush Palette, 4.23
- Colors
 - background, 1.3
 - brush, 1.4
 - foreground, 1.4
 - number available, 2.13
 - page, 1.3
 - creating, 2.14-2.16, 3.2-3.10
- Color Settings dialog box, 4.21
- Command key, 1.4, 1.5, 2.2, 2.3, 2.17-2.20
- Constraining lines and shapes, 1.9
- Continuous Freehand tool, 1.7, 4.25
- Control key (CTRL), 1.10
- Coordinates command, 4.5
- Copy command, 4.5
- Copy to Spare command, 4.11
- Crosshair pointer, 1.5, 4.34
- Cubes, creating, 3.30-3.32
- Cursors, 4.35
- Curve tool, 1.7-1.8, 4.26
 - modifying, 2.17-2.18

INDEX

- Cut command, 4.5
- Cycle command (Color menu), 3.11, 4.22
- Cycle command (Mode menu), 4.14
- D**
- Default Palette command, 1.15, 4.22
- Default color settings, 1.3
- Delete this Page command, 4.12
- Desk Accessories, 4.2
- Disks, copying, 1.1-1.2
- Dither, 2.19-2.20, 4.27
- Dotted Freehand tool, 1.7, 4.25
- Dotted lines, 2.17-2.18
- Double command, 4.15
- Double Horizontal command, 4.16
- Double Vertical command, 4.16
- Drop shadows, 3.16
- E**
- Edit menu, 4.4-4.8
 - Brush Handle, 2.4-2.5, 4.7
 - Copy, 4.5
 - Coordinates, 4.5
 - Cut, 4.5
 - Excl Brush, 2.8, 4.7
 - Fast Feedback, 2.5, 4.5
 - Info Bar, 2.6, 4.6
 - Paste, 4.5
 - Square Aspect, 4.8
 - Undo, 4.4
- Ellipse tool, 1.10, 4.27-4.28
- Excl brush, 2.8, 4.7
- F**
- Fast Feedback command, 2.5, 4.5
- File menu, 4.2-4.4
 - Load Brush, 4.3
 - Load Picture, 4.2
 - Load Stencil, 4.3
 - Choose Printer, 4.4
 - Print, 4.4
 - Quit, 4.4
 - Save Brush, 4.3
 - Save Picture, 4.2
 - Save Stencil, 4.3
- Files
 - loading, 1.14-1.1
 - naming, 1.13
 - saving, 1.12-1.14
- Fill tool, 1.8, 3.15, 4.26-4.27
 - modifying, 2.18-2.20
- Fill Type dialog box, 2.18
- Fix Background, 1.15-1.16, 2.12, 3.23-3.24, 4.11
- Flip Horizontal command, 4.15
- Flip Vertical command, 4.15
- Folders, 1.13
 - creating, 4.3
 - naming, 4.3
 - opening, 1.15
- Font menu, 2.22, 4.24
 - Point Sizes (8, 10, 12, 14), 4.24
- Foreground color, 1.4
- Free Background, 1.16, 4.12
- Free Stencil command, 3.23-3.24, 4.12
- Friskets, 3.19-3.24
- G**
- Gradient Fill, 2.16, 2.19-2.20, 3.8, 3.17-3.18, 4.26-4.27
- Grid dialog box, 2.8
- Grid tool, 2.7-2.9, 3.30-3.32, 4.29-4.30
 - modifying grid, 2.20
- H**
- Halve, 4.15
- Handle, brush, 2.4-2.5, 4.14
- Hardware, 1.1
- High Resolution format, 2.13, 4.9
- HSV color mixing, 2.15
- I**
- Info Bar, 2.6, 4.6
- K**
- Keyboard commands
 - brushes, 4.32
 - Palette Window, 4.34
 - perspective, 4.32-4.33
 - special, 4.34
 - tools, 4.25-4.31, 4.33
- Keydisk system, 1.2
- L**
- Load Brush command, 4.3
- Load Picture command, 1.14-1.15, 4.2
- Load Picture dialog box, 1.14
- Load Stencil command, 4.3
- Lock Foreground, 3.24, 4.10
- Logo tutorial, 3.12-3.18

INDEX

M

Magnify tool, 2.6, 4.30
Make Stencil command, 3.20-3.24, 4.9-4.10
Make Stencil dialog box, 3.20
Matte command, 3.16-3.17, 4.12
Medium Resolution format, 2.13, 4.9
Memory availability display, 4.6, 4.34
Menu Bar, 1.12, 4.1
 hiding, 2.6
Mixing palette, 2.14-2.16
Mode menu, 2.21, 4.12-4.14
 Blend, 2.20-2.21, 4.13
 Color, 3.16, 3.17, 4.12
 Cycle, 4.14
 Matte, 3.16, 3.17, 4.12
 Multi-Cycle, 4.14
 Replace, 4.12
 Shade, 2.20-2.21, 4.13
 Smear, 2.20-2.21, 4.12
 Smooth, 2.20-2.21, 4.14
Mouse button, 1.4, 1.6, 4.25-4.31
 with Command key, 1.4, 1.5-1.16, 2.3,
 2.17-2.20, 4.25-4.31
Multi-Cycle command, 4.14

O

Options command, 3.29, 4.19
Outline of a shape, creating, 3.17

P

Page Size command, 2.12, 4.8-4.9
Pages, 1.3, 2.11-2.12
 color, 1.3
 copy to spare page, 4.11
 delete current page, 4.12
 reduced view, 4.9
 size, 2.12, 4.8-4.9
 switching, 2.11, 4.11
Paint can. *See* Fill tool
Painting area, 1.3
Painting modes, 2.20-2.21, 4.6, 4.12-4.14
Painting Screen, 1.3
Palette, 1.3-1.4, 2.13-2.16, 3.2, 4.20-4.22, 4.31
 creating, 3.2-3.10
 default, 1.15
 restoring, 1.15
Palette command, 4.20-4.22
Palette Window, 2.13-2.16, 3.2, 4.20-4.22
 copying colors, 2.16, 3.3, 4.21
 exchanging colors, 2.16, 4.21

 Gradient Fill, 2.16, 3.8-3.10, 4.26-4.27
 modifying Palette, 3.2-3.10
 range for gradient fill, 3.8-3.10, 3.17-3.18
 ranges and spreads, 3.6-3.10, 4.21
Paste command, 4.5
Pattern fill, 3.15, 4.26
Perspective, 2.5, 3.25-3.36, 4.16-4.20
 anti-aliasing, 3.29, 4.19-4.20
 axes, 3.25
 brush, 2.5
 command, 4.16-4.20
 fill, 4.19, 4.26
 fixing axes, 3.33-3.36, 4.17-4.18
 keyboard command summary, 4.32-4.33
 rotating brush on axis, 3.26-3.36,
 4.17-4.18
 rotation, absolute and relative, 4.19
 rotation value of Shift key, 3.28,
 4.29-4.30
 setting perspective center, 3.27, 4.17
Perspective Grid dialog box, 4.30
Perspective Options dialog box, 4.19
Pict menu, 4.8-4.12
 Copy to Spare, 4.11
 Delete this Page, 4.12
 Fix Background, 4.11
 Free Background, 4.11
 Free Stencil, 4.11
 Lock Foreground, 4.10
 Make Stencil, 4.9-4.10
 Page Size, 4.8-4.9
 Reverse Stencil, 4.10
 Screen Format, 4.9
 Show Page, 4.9
 Spare Page 2.11, 4.11
 Toggle Stencil, 4.10
Pixel, 1.6
Polygon tool, 1.10-1.11, 4.28
Power up, 1.2-1.3
Print command, 4.4

Q

Quit command, 4.4

R

Rectangle tool, 1.9, 4.27
Remap Brush command, 2.4, 4.24
Remap Picture command, 4.23
Replace command, 4.12
Resolutions, screen, 2.13, 4.9
Restore Palette command, 1.15, 4.22

INDEX

Reverse Stencil command, 4.10
RGB color mixing, 2.14-2.15
Rotate command, 4.15

S

Save Brush command, 1.12, 4.3
Save Picture command, 1.12-1.14, 4.2-4.3
Save Picture dialog box, 1.13
Save Stencil command, 4.3
Screen Format command, 2.13, 4.9
Screen resolutions, 2.13, 4.9
Scroll box, 1.13
Set Page Size dialog box, 4.8
Shade command, 2.21, 4.13
Shape tools, modifying, 2.18-2.20
Shear command, 3.12, 4.16
Shift key, 1.9, 3.28, 4.28-4.29
Show Page command, 2.12, 4.11
Single-drive operation, 1.2
Slanting image, 3.12
Smear command, 2.20-2.21, 4.12
Smooth command, 2.20-2.21, 4.14
Spacebar, 1.8, 2.3, 4.34
Spacing dialog box, 2.18
Spare Page command, 2.11, 4.11
Spread, color, 3.6-3.8, 4.21
Square Aspect, 1.9, 4.8
Stencils, 3.19-3.24, 4.9-4.11
Straight Line tool, 1.7, 4.25-4.26
 modifying, 2.17-2.18
Stretch command, 3.13, 4.15
Symmetry dialog box, 2.9
Symmetry tool, 2.9-2.10, 4.30
 modifying, 2.20

T

Text, 2.21-2.22, 4.29
Toggle Stencil, 4.10
Toolbox, 1.4, 1.5, 1.7-1.12, 4.25-4.31. *See also*
 individual tool names
 hiding, 2.6
 keyboard commands, 4.25-4.31, 4.32-4.34
 modifying tools, 2.17-2.20
Traces, 1.10

U

Undo button, 1.4, 1.15, 4.31
Undo command (in Edit menu), 4.4
Use Brush Palette command, 2.4, 3.12, 3.26,
4.23

V

Version number information, 4.2

Z

Zoom, 2.7, 4.31



CREDITS AND ACKNOWLEDGEMENTS

Software design and development: Daniel Silva
Software Adaptation for IIGS: Brent Iverson
Producers: David Grady, Greg Riker
Assistant Producers: Shelley Day, Jeff Johannigman, Happy Keller
Manual: Nicholas Lavroff
Manual Adaptation for IIGS: Carolyn McFarlane
Tutorial Design: Richard Antaki, Paul Reiche III
Product Manager: Stu Roberson
Program Art: Richard Antaki, Paul Reiche III, Dan Silva
Package Design: Davison Design
Package Art: Richard Antaki, Avril Harrison, Paul Reiche III
Art Direction: Judy Campbell
Photography: Frank Wing

Special thanks to Steve Shaw for developing the prototype code for 3D brush rotation.

About our company: We're an association of electronic artists who share a common goal. We want to fulfill the potential of personal computing. That's a tall order. But with enough imagination and enthusiasm, we think there's a good chance for success. Our products, like this one, are evidence of our intent. If you'd like a product brochure, send \$1.00 and a self-addressed, stamped envelope to: Electronic Arts Catalog Request, 1820 Gateway Drive, San Mateo, CA 94404.





NOTICE

ELECTRONIC ARTS RESERVES THE RIGHT TO MAKE IMPROVEMENTS IN THE PRODUCT DESCRIBED IN THIS MANUAL AT ANY TIME AND WITHOUT NOTICE.

THIS MANUAL IS COPYRIGHTED. ALL RIGHTS ARE RESERVED. NO PART OF THIS MANUAL MAY BE COPIED, REPRODUCED, TRANSLATED OR REDUCED TO ANY ELECTRONIC MEDIUM OR MACHINE READABLE FORM WITHOUT THE PRIOR WRITTEN CONSENT OF ELECTRONIC ARTS, 1820 GATEWAY DRIVE, SAN MATEO, CALIFORNIA 94404.

ELECTRONIC ARTS MAKES CERTAIN LIMITED WARRANTIES WITH REGARD TO DEFECTIVE RECORDING MEDIA. PLEASE SEE THE ELECTRONIC ARTS LIMITED WARRANTY ENCLOSED WITH THIS PRODUCT.

SOFTWARE © 1987 ELECTRONIC ARTS

MANUAL BY NICHOLAS LAVROFF
© 1987 ELECTRONIC ARTS





ELECTRONIC ARTS®
DELUXE CREATIVITY SERIES

1820 Gateway Drive, San Mateo, CA 94404 (415) 571-7171

123305